



teknion

what is focus

what is focus

WHAT IS FOCUS. 8

PLANNING CONSIDERATIONS 9

what is focus

what is focus

Focus is a demountable wall system that seamlessly integrates a variety of glass and solid fascias to create an array of modern, architecturally refined enclosures.

The system can be tailored to specific site conditions and acoustic requirements through a comprehensive glass wall and door pairing program. All pairings maintain visual and acoustic continuity throughout the wall run.

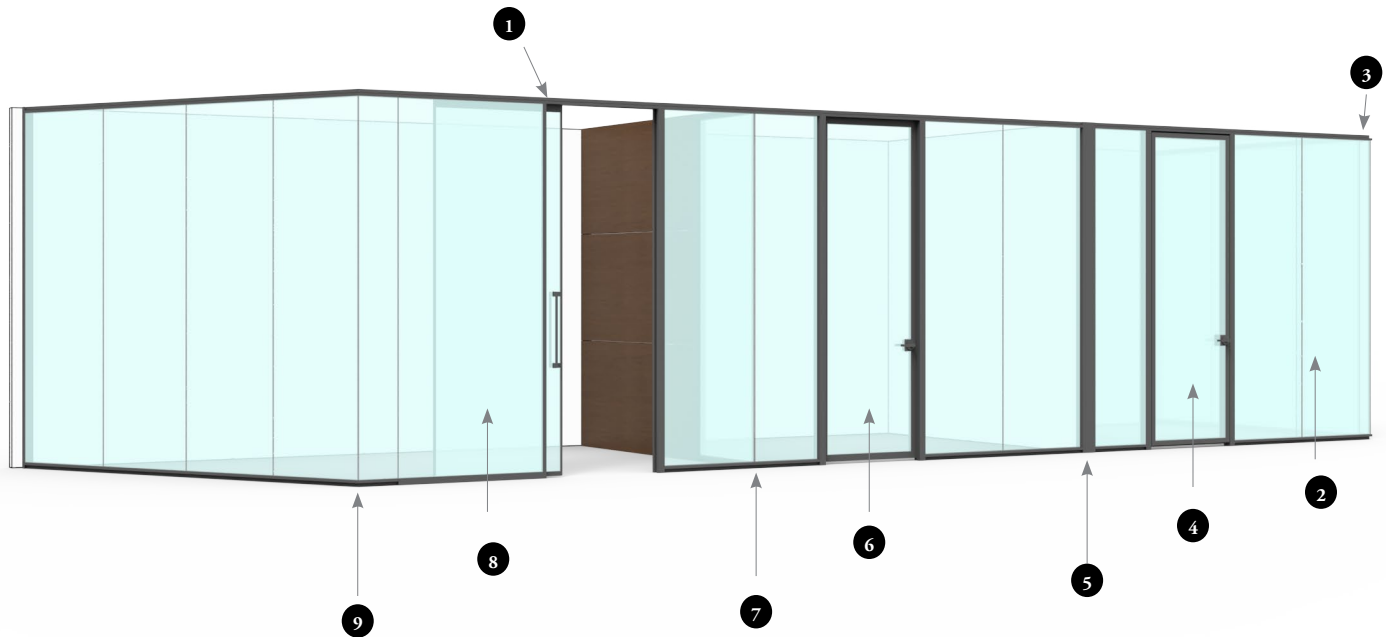

The following Focus components are demonstrated above:

- 1 Single Glazed Sliding Door
- 2 Double Glass Fascia
- 3 90° Glass Corner Connector Kit (Double Glass)
- 4 Double Glazed Pivot Door
- 5 Corner Transition
- 6 Single Glazed Pivot Door
- 7 Three-Way Corner – Offset Glass
- 8 Offset Single Glass Fascia
- 9 90° Glass Connector Kit (Single Glass)

planning considerations

When specifying Focus, the following site condition steps and rules must be followed.

step 1: determine the site condition

Scenario A. Pre-constructed Site

- A. If the site has not yet been constructed Steps 6-8 must be followed prior to specification
- B. Establish desired nominal floor to ceiling height
- C. For applications that include a Sliding Door, the General Contractor must hold the nominal floor to ceiling height within +/- 1/8" over 10'
- D. The General Contractor must hold the building architecture within +/- 1/4" over length of wall span (tighter tolerances may be required when adjustable wall start applications are not used)
- E. Once the site is constructed, the nominal floor to ceiling height must be validated prior to installation

Scenario B. Constructed Site

- A. If the site is already constructed Steps 2-8 must be followed prior to specification

step 2: survey and measure the building site

- A. Use a laser to shoot the entire site to find the high and low spots in the finished floor and ceiling. Finished floor to ceiling measurements should be recorded every 12" along each linear span of Focus

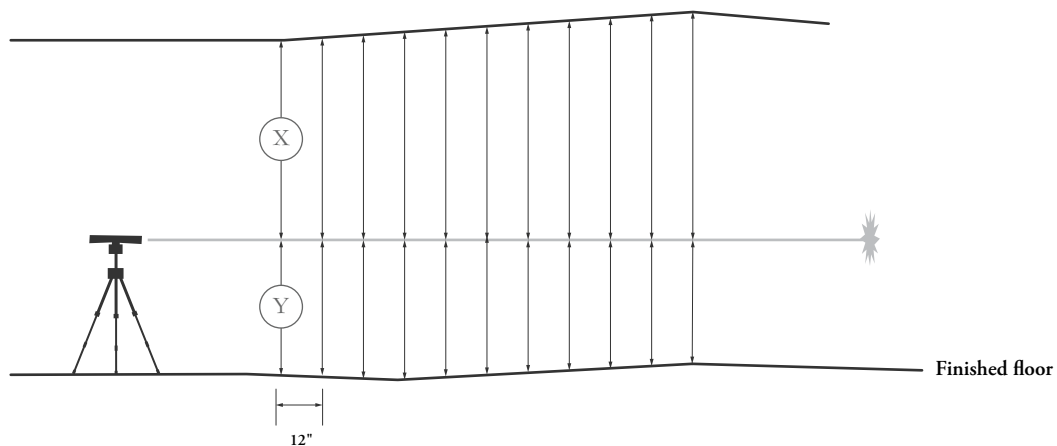

- B. Consider the location of HVAC and lighting panels on the ceiling before laying out wall runs. Focus should be planned to optimize the amount of natural light that will flow into corridors for energy savings and LEED credits

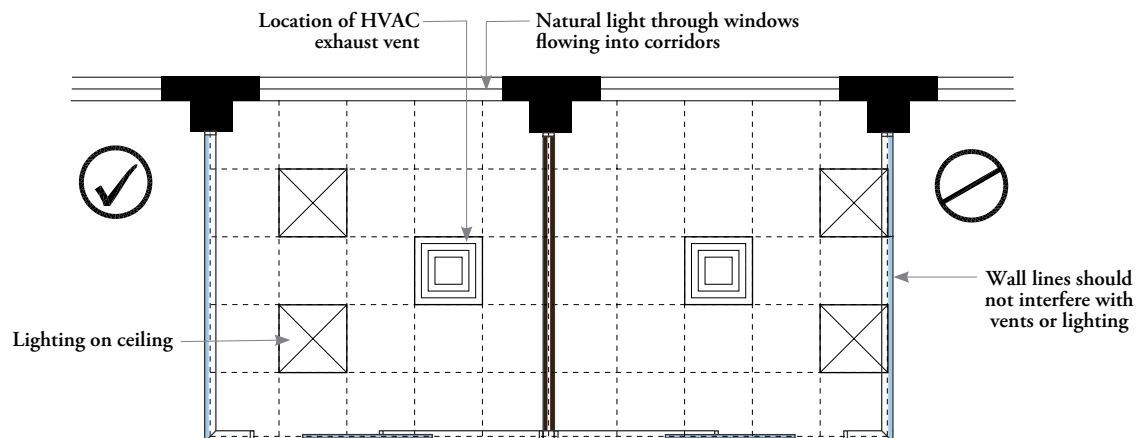

planning considerations (continued)

step 3: evaluate floor to ceiling deviations

Consider the leveling range of Focus and the nominal floor to ceiling height:

- The finished floor to ceiling height **cannot** expand more than 28mm over 10' in one wall run (+11mm in ceiling, +17mm in floor)
- The finished floor to ceiling height **cannot** contract more than 14mm over 10' in one wall run (-10mm in ceiling, -4mm in floor)

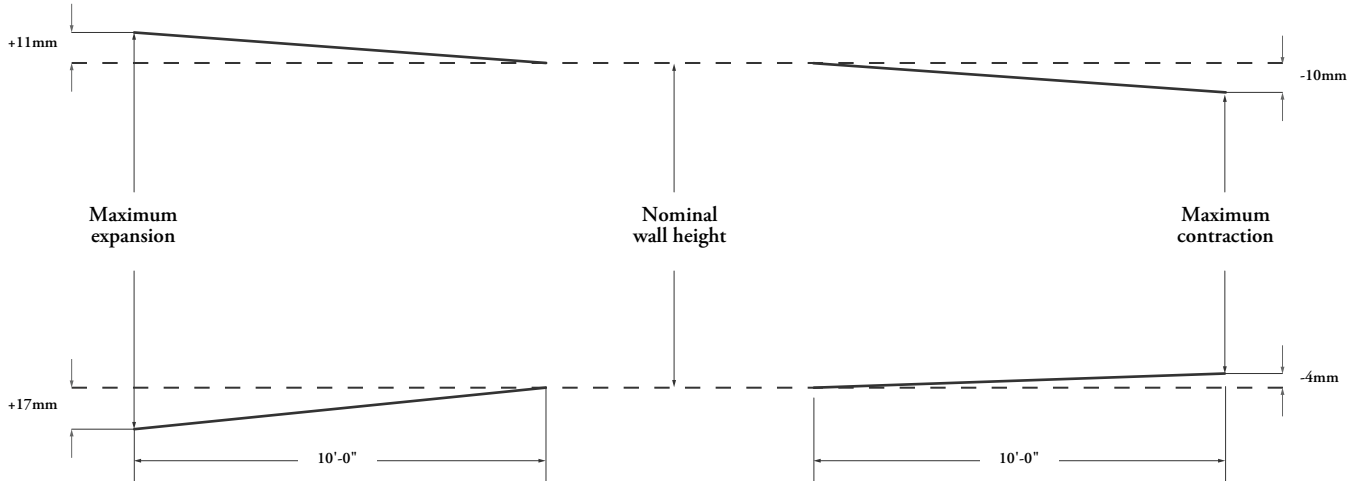

If the floor to ceiling deviations have exceeded these limits a wall end, wall start or vertical inline transition must be specified to reset nominal leveling. The following describes how to plan wall runs between verticals to allow for height transitions:

Gradual slope

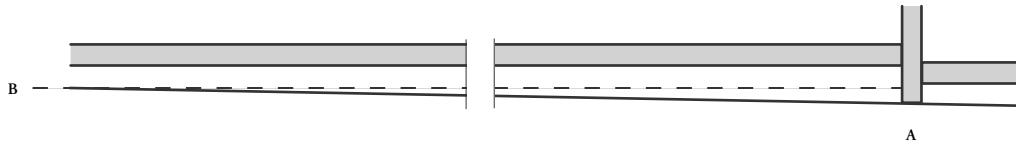

Valley

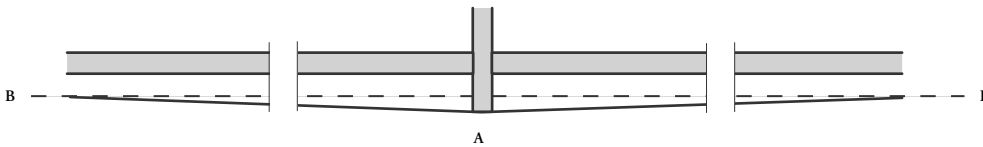

Hill

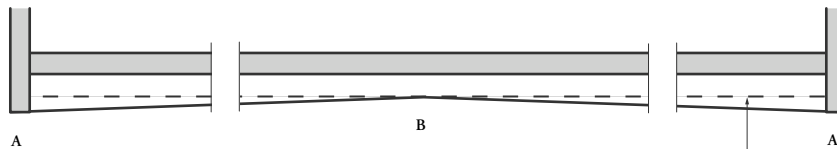

Legend summary

A: Nominal leveling reset

B: Nominal set point

Compressible shim required on either end

planning considerations (continued)

step 4: plan nominal heights with pivot and hinged doors

Pivot and hinge door frames are considered to be part of the wall run. The minimum floor to ceiling height within the door frame or swing area determines the nominal door and wall height of the run. On-site measurements should be checked against existing drawings prior to installation.

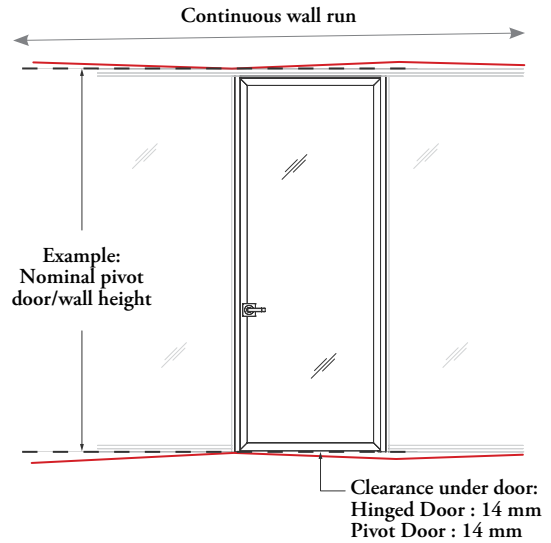
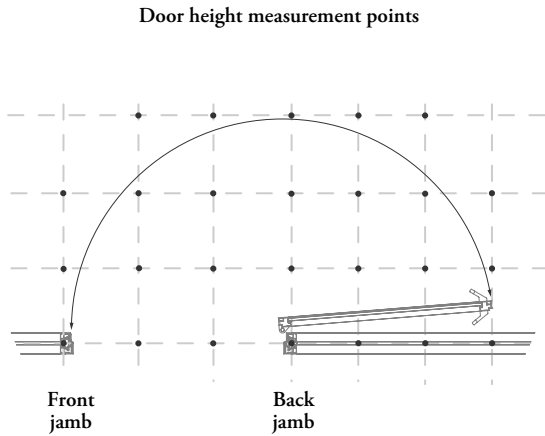

The following describes how to plan wall runs with pivot or hinged doors based on leveling limitations:

Scenario A:
Door and wall within leveling limits

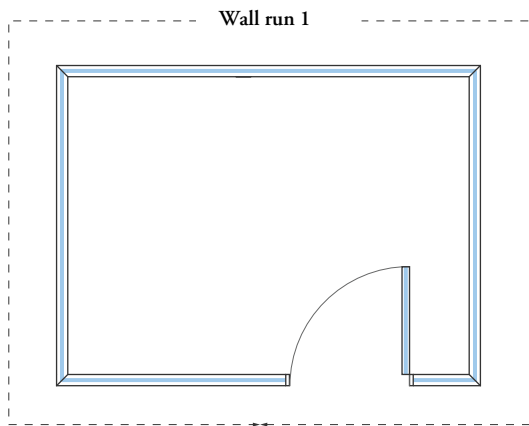

A. Run can be joined

Scenario B:
Door and wall leveling limits exceeded

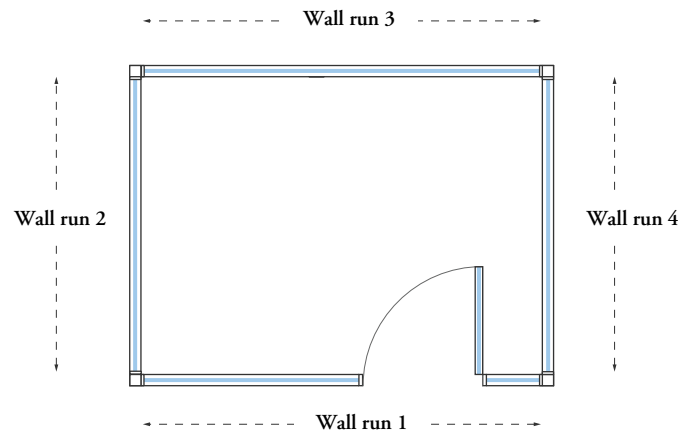

B. Runs are separated with wall ends to reset nominal leveling (other reset options can include wall starts and inline glass transitions)

planning considerations (continued)

step 5: plan nominal heights with sliding doors

Sliding door frames are considered to be part of the wall run. The minimum floor to ceiling height within the door frame determines the nominal door and wall height of the run. Measurements should be taken every 12" within the linear span of the door frame.

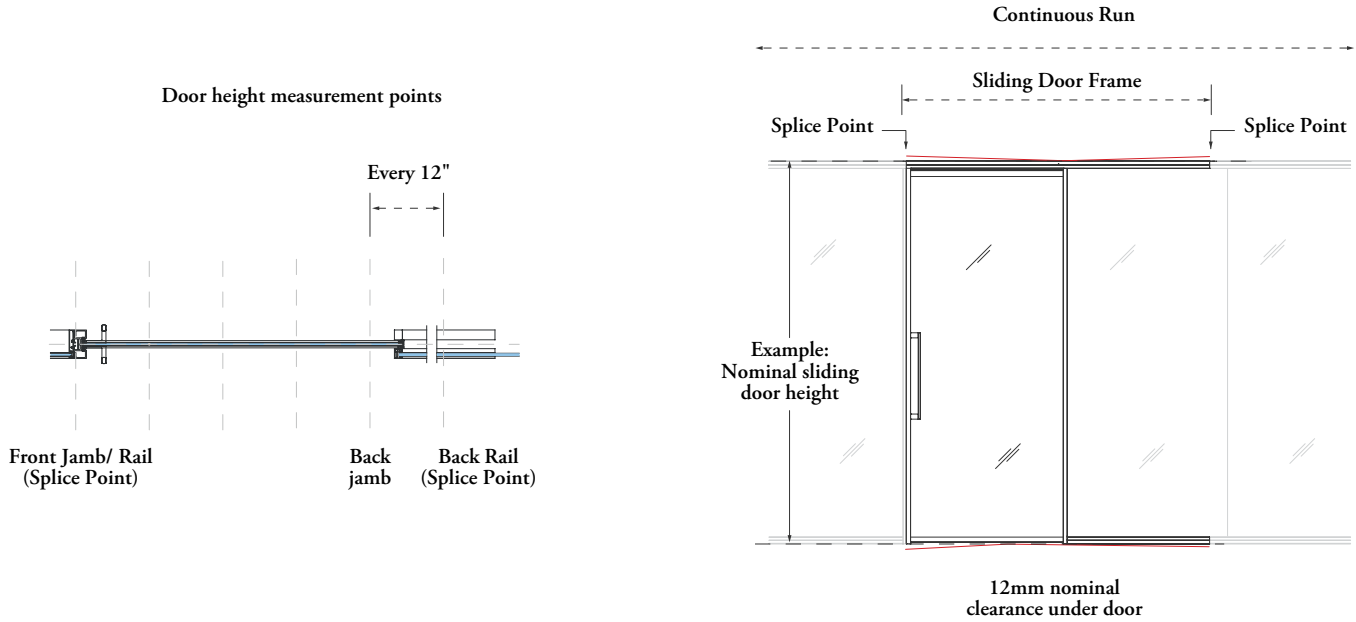

The following illustrations compare the profile elevation between a sliding door frame and a standard fascia frame. Both frames can be spliced together to create a continuous run without the need for a third post.

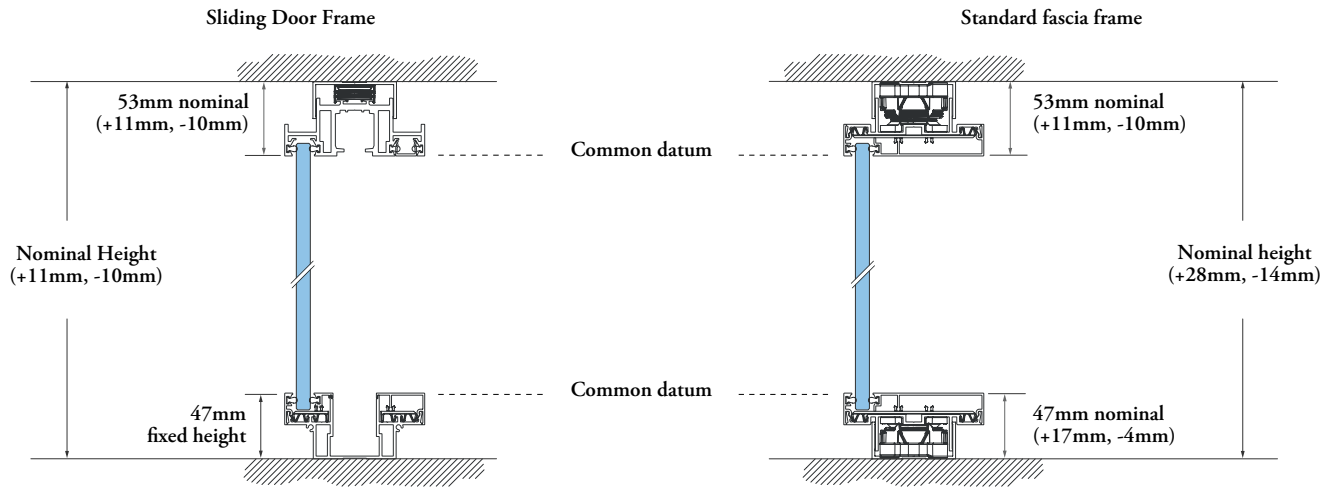

Refer to Focus Frame Leveling page for more information.

planning considerations (continued)

step 6: plan wall runs

Focus allows for three distinct types of runs:

- Runs that start
- Runs that end
- Runs that join

These runs can be combined to create the following conditions and tolerances:

Legend Summary

- A - Adjustable wall start
- B - Building and/or install requirement
- C - Cut from factory (1/16" increments)

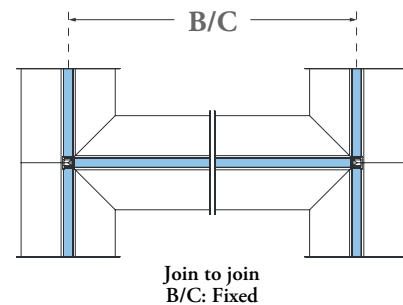
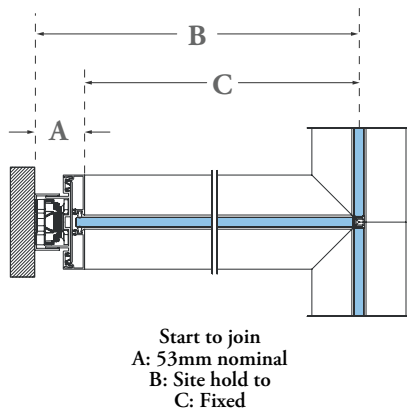
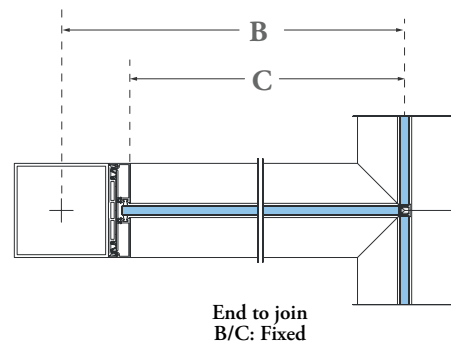
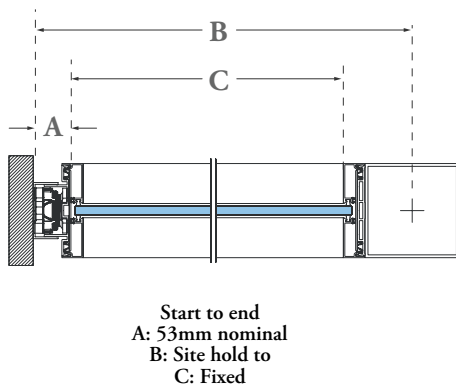
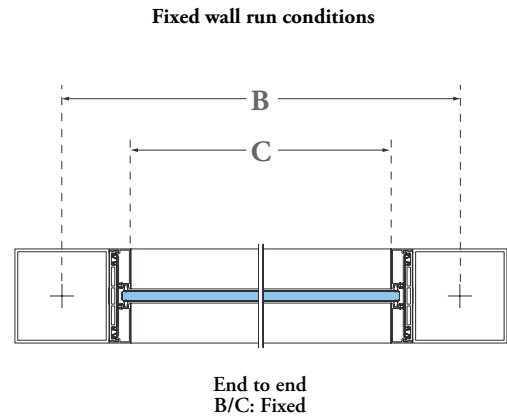
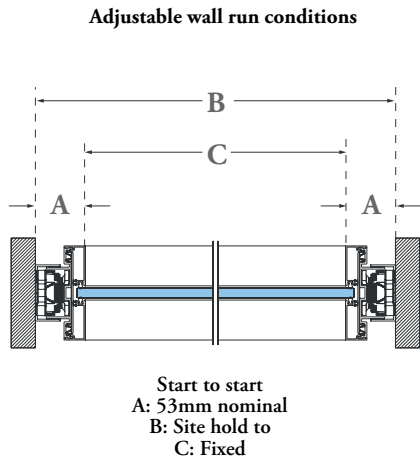

planning considerations (continued)

step 7: plan to accommodate existing building architecture

The following demonstrates adjustable and fixed wall conditions.

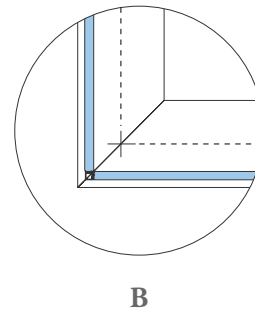
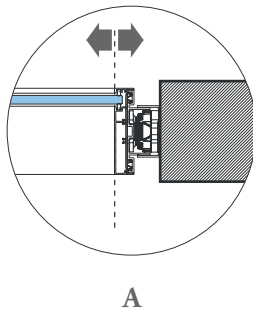
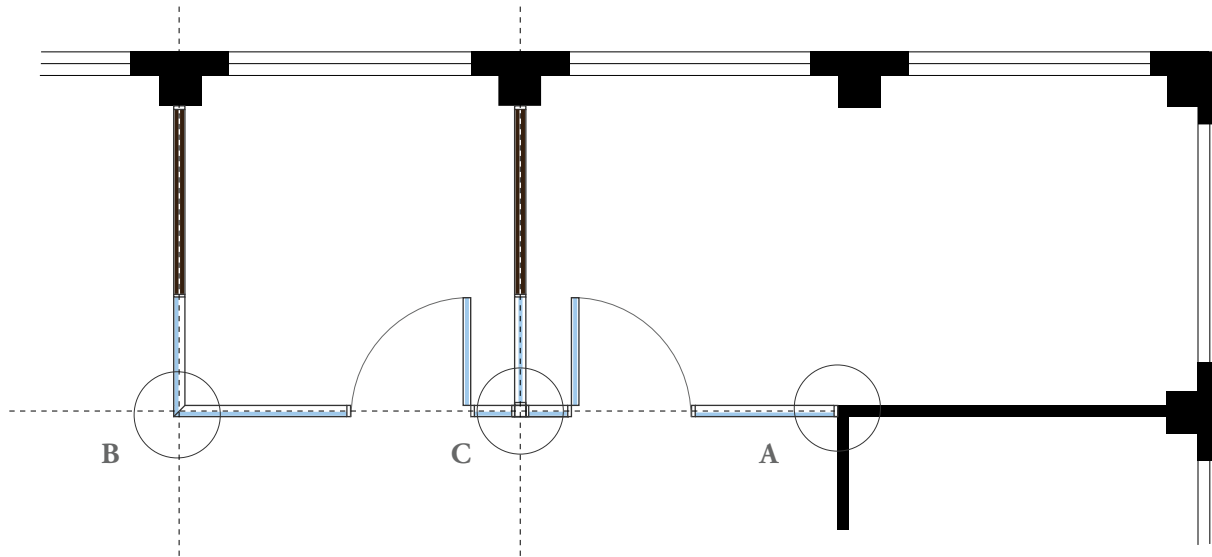

Use wall starts when connecting to building architecture to allow for on-site adjustability.

Join conditions are considered fixed datum points during installation.

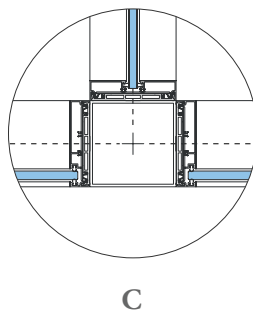



Wall end conditions are considered fixed datum points during installation.

planning considerations (continued)

step 8: consider wall and door acoustic pairing

Ensure that the wall and door specification for each room is logical from an acoustical perspective to ensure optimal performance. The chart below illustrates a basic guideline for door to wall acoustic alignment:

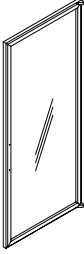
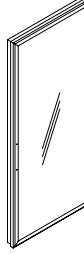
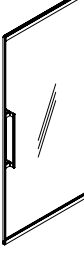
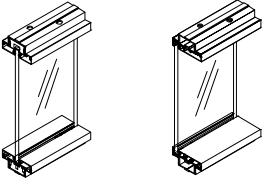
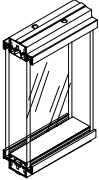
					
	Single Leaf Single Glazed Hinged Door (FWSSH)	Single Leaf Solid Hinged Door (FWSOH)	Single Leaf Single Glazed Pivot Door (FWSSP) and Double Leaf Single Glazed Pivot Door (FWDSP)	Single Leaf Double Glazed Pivot Door (FWSDP)	Single Leaf Sliding Door Framed (FWSSL)
 Center and offset glass	✓		✓		✓
 Double glass		✓		✓	

Any door can be joined to any wall if desired, but may **not** be an ideal acoustic solution.

application guide

application guide

PRODUCT MAP	19
HORIZONTAL FRAMES	29
GLASS FASCIAS & CONNECTORS	39
DOORS	47
WALL STARTS	71
WALL TRANSITIONS & WALL ENDS	75
ACCESSORIES	83

horizontal frames cut on-site product map

M F W C X Cut On-Site Ceiling Frame Assembly

M F W B X Cut On-Site Base Frame Assembly

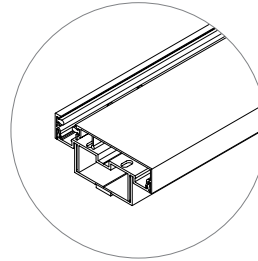
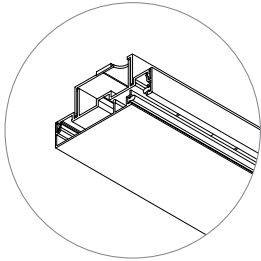

fascias & connectors product map

M F W G A Glass Fascia – 10mm Thickness



M F W G B Glass Fascia – 12mm Thickness

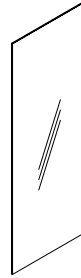

M F W I P Glass Connector Kit – Inline Clear Plastic

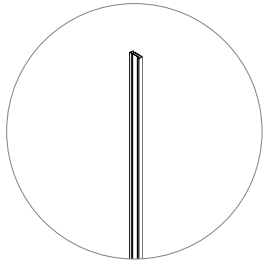

M F W I T Glass Connector Kit – Inline Tape

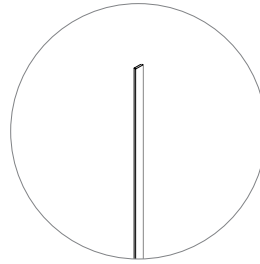

M F W V P Glass Connector Kit - Variable Angle
Clear Plastic

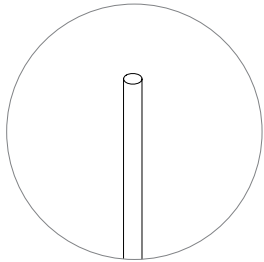

M F W C N 90° Glass Connector Kit

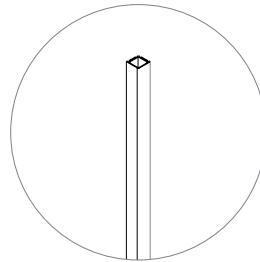

M F W C T Three-Way Glass Connector Kit

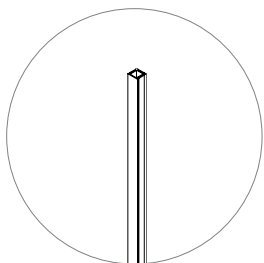

doors product map

M F W S S H L Single Leaf Solid Hinged Door

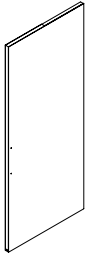

M F W D S H L Double Leaf Solid Hinged Door

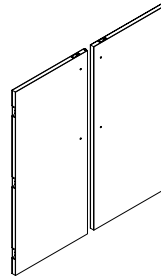

M F W S G P L Single Leaf Single Glazed Pivot Door

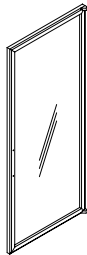

M F W D G P L Double Leaf Single Glazed Pivot Door

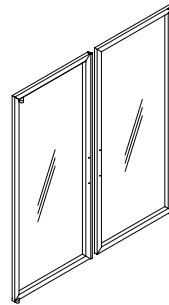

M F W S O P L Single Leaf Double Glazed Pivot Door

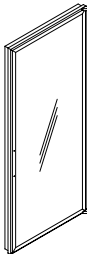

M F W D O P L Double Leaf Double Glazed Pivot Door

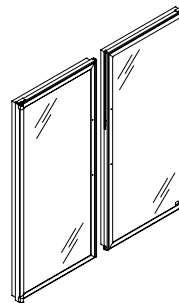

M F W S F S L Framed Single Leaf Single Glazed Sliding Door



M F W D F S L Framed Double Leaf Single Glazed Sliding Door

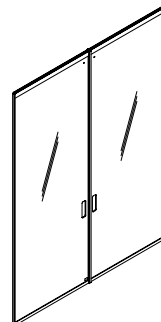

doors product map

M F W S H D J Single Leaf Hinged Door Jamb Kit



M F W D H D J Double Leaf Hinged Door Jamb Kit

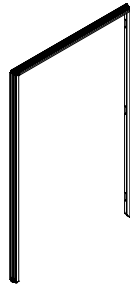

M F W S P D J Single Leaf Pivot Door Jamb Kit

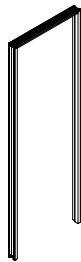

M F W D P D J Double Leaf Pivot Door Jamb Kit

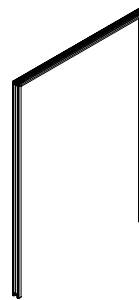

M F W S S D J Single Leaf Sliding Door Infinite Jamb Kit

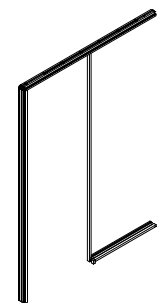

M F W D S D J Double Leaf Sliding Door Infinite Jamb Kit

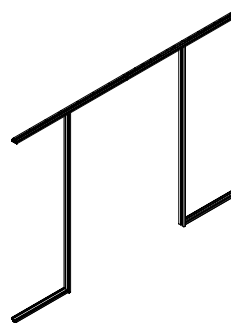

M F W D S C P Door Handle Ceiling Pull

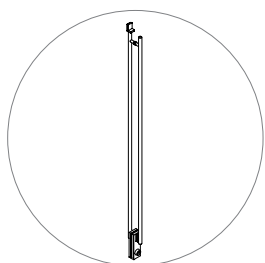

M F W D S F P Door Handle Floor Pull

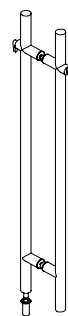

application guides
doors product map

M F W D H L P Door Handle Linear Pull

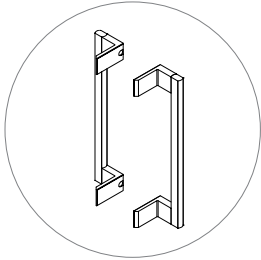

M F W D H S X Door Handle Schlage ALX Series

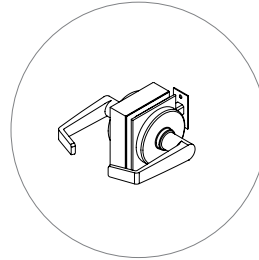

M F W D H S N Door Handle Schlage ND Series

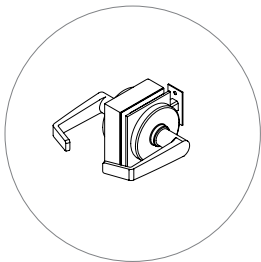

M F W W D S S C Wall Door Start Single Centered Glass

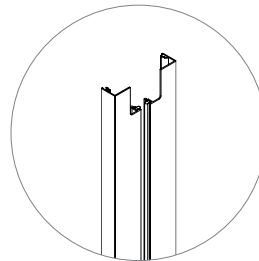

M F W W D S S O Wall Door Start Offset Glass

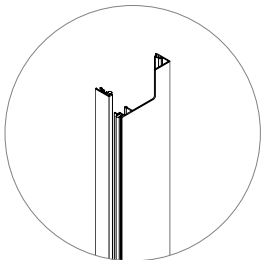

M F W W D S D G Wall Door Start Double Glass

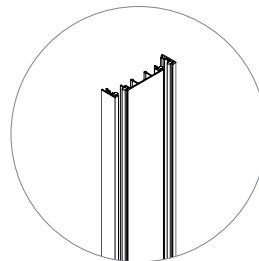

wall starts product map

M F W W S S C Wall Start Single Centered Glass

M F W W S S O Wall Start Single Offset Glass

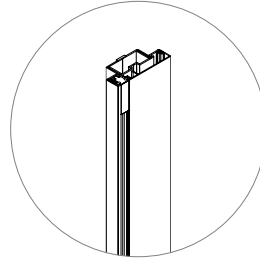
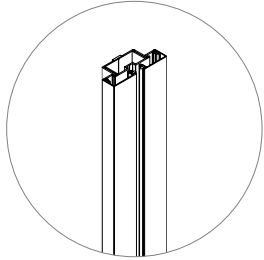

M F W W S D G Wall Start Double Glass

M F W W S D D Wall Start Door

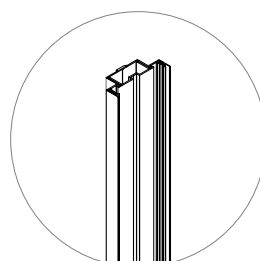
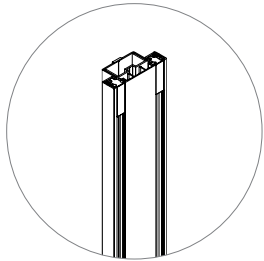

wall transitions & wall ends product map

M F W T C D Corner Transition

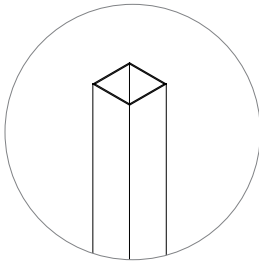

M F W T C F A Inline Transition Connection –
Focus to Altos

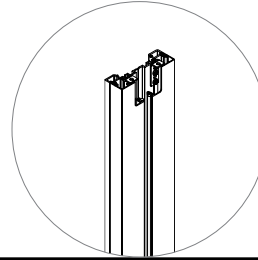

M F W W E S C Wall End Inline Single Centered Glass

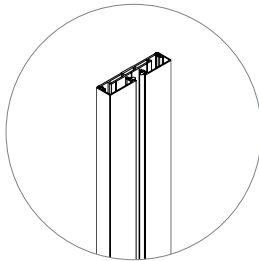

M F W W E S O Wall End Inline Offset Glass

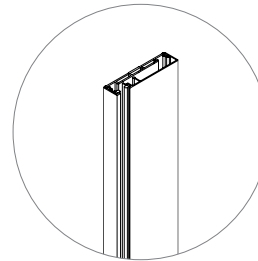

M F W W E D G Wall End Inline Double Glass

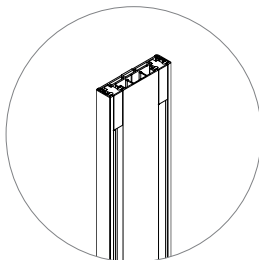

M F W W E D Wall End Inline Door

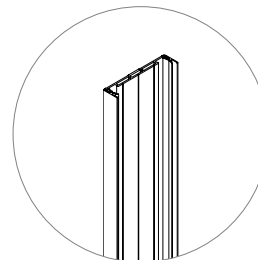

accessories product map

M F W R S Door Stop

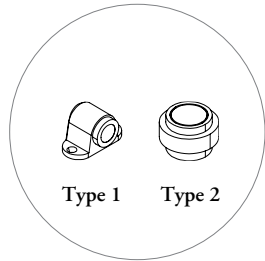

M F W A S K Splice Kit

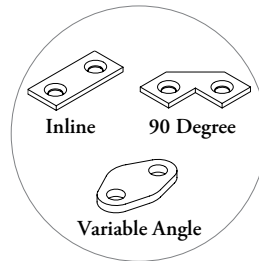

M F W C K Ceiling Clip

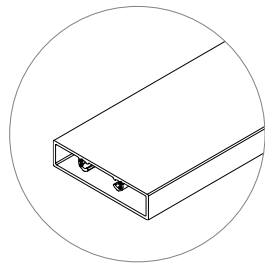

M F W K K Control Key

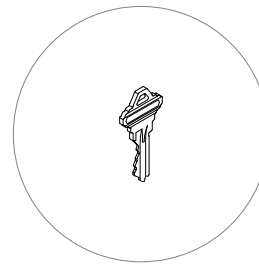

M F W A K Activator Kit

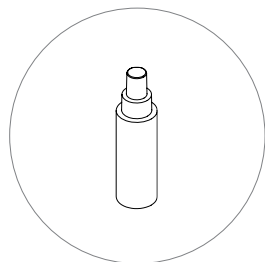

M F W T K Installation Tool Kit

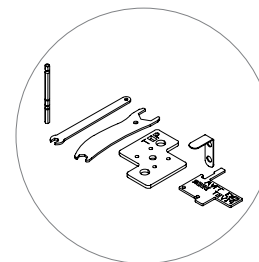

M F W M K Micro-Leveler Kit

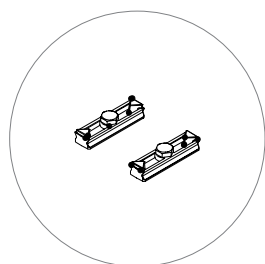

M F W F X Frame Cut Fixture

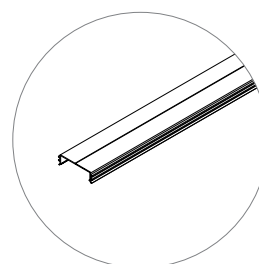

horizontal frames

horizontal frames

UNDERSTANDING HORIZONTAL FRAME ASSEMBLIES	30
SINGLE FRAME ASSEMBLY BASICS	31
DOUBLE FRAME ASSEMBLY BASICS	32
PLANNING WITH HORIZONTAL FRAMES	33

understanding horizontal frame assemblies

Focus frames consist of ceiling, base and vertical frames and are available to accommodate 10mm and 12mm glass fascias.

The following outlines the components of the ceiling and base assemblies.

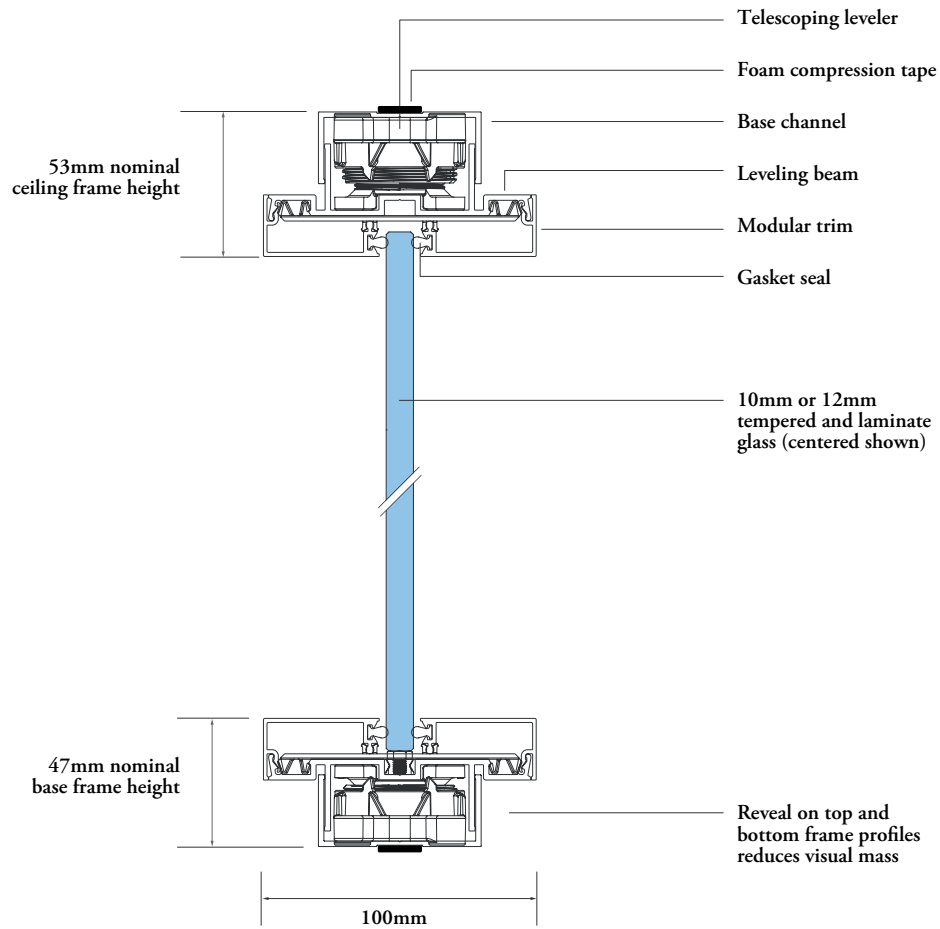

A variety of glass and solid fascia mounting options are available with horizontal frames.

Inline (shown)

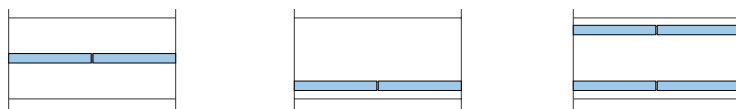

Center glass

Offset glass

Double glass

single frame assembly basics

Single frame assemblies allow for a single 10mm or 12mm glass fascia to be mounted in the center or offset location of a frame.

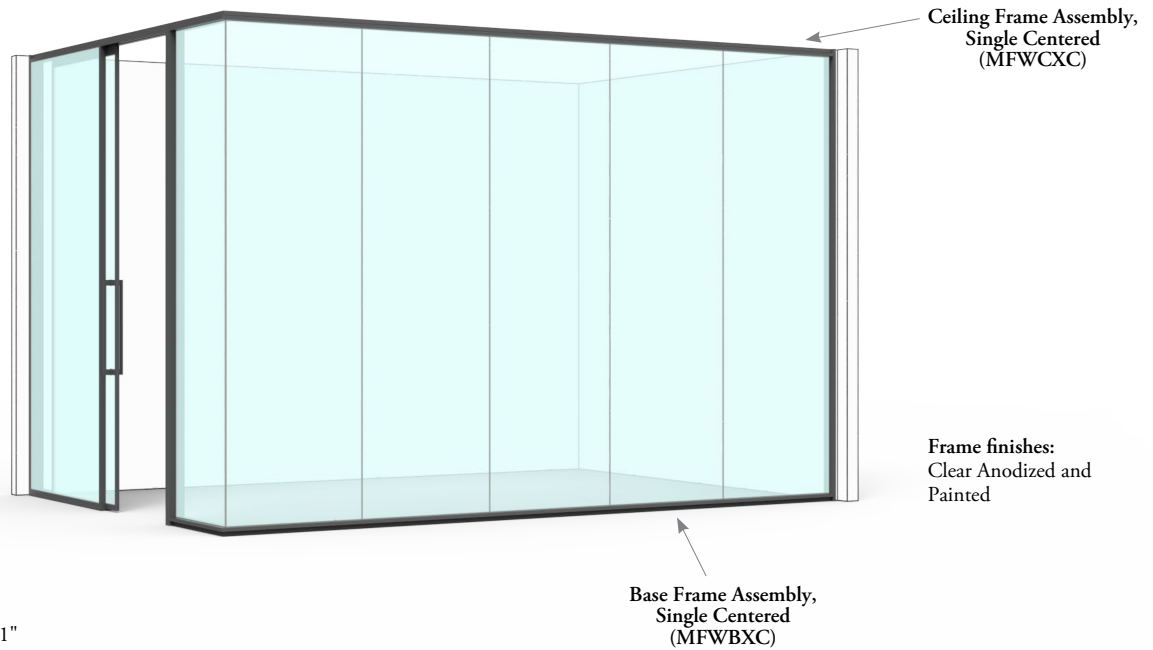

- Extrusions available at 121"
- Extrusions are available in three conditions
 - Angled
 - Three-way mitered
 - Four-way mitered
- When specifying extrusions a left and right angled increment must be selected
- The increments represent the two extrusion angles (when viewed from the exterior) required to make up the overall planning angle required

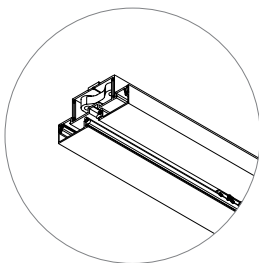

Ceiling Frame Assembly, Single Centered (MFWCXC)

- Adjustable ceiling frame for single centered glass fascias

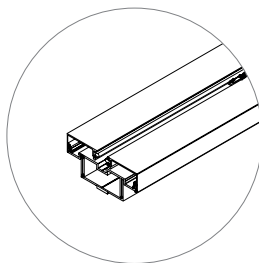

Base Frame Assembly, Single Centered (MFWBXC)

- Adjustable base frame for single centered glass fascias

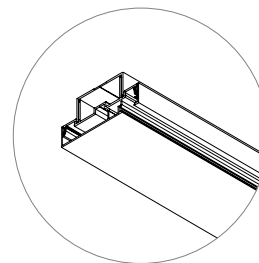

Ceiling Frame Assembly, Single Offset (MFWCXO)

- Adjustable ceiling frame for offset single centered glass fascias

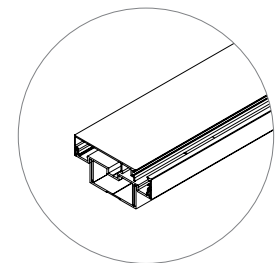

Base Frame Assembly, Single Offset (MFWBXO)

- Adjustable base frame for offset single centered glass fascias

double frame assembly basics

Double frame assemblies allow for double 10mm or 12mm glass fascias to be mounted to the frame.

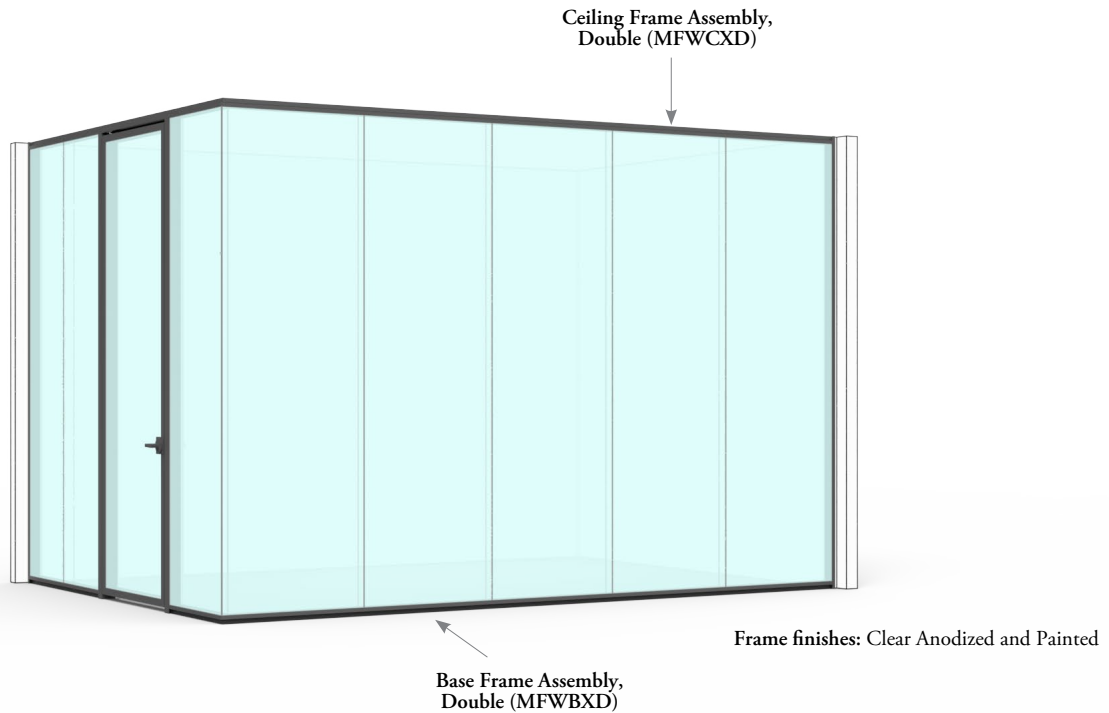

- Extrusions available at 121"
- Extrusions are available in three conditions
 - Angled
 - Three-way mitered
 - Four-way mitered
- When specifying extrusions a left and right angled increment must be selected
- The increments represent the two extrusion angles (when viewed from the exterior) required to make up the overall planning angle required

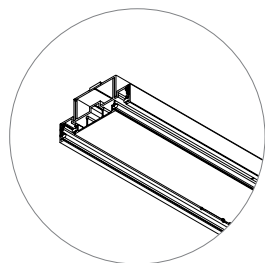

Ceiling Frame Assembly, Double (MFWCXD)

- Adjustable ceiling frame for double glass fascias

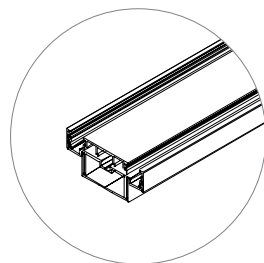

Base Frame Assembly, Double (MFWBXD)

- Adjustable base frame for double glass fascias

planning with horizontal frames

The following describes the floor to ceiling leveling accommodation provided by Focus horizontal frames.

- If the site is in a constructed condition, the nominal floor to ceiling height is determined through site measurements and specification software
- Based on the nominal floor to ceiling height, base and ceiling frame have an overall leveling range of 42mm (+28mm / -14mm)
 - Ceiling frame has an overall leveling range of 21mm (+11mm / -10mm)
 - Base frame has an overall leveling range of 21mm (+17mm / -4mm)

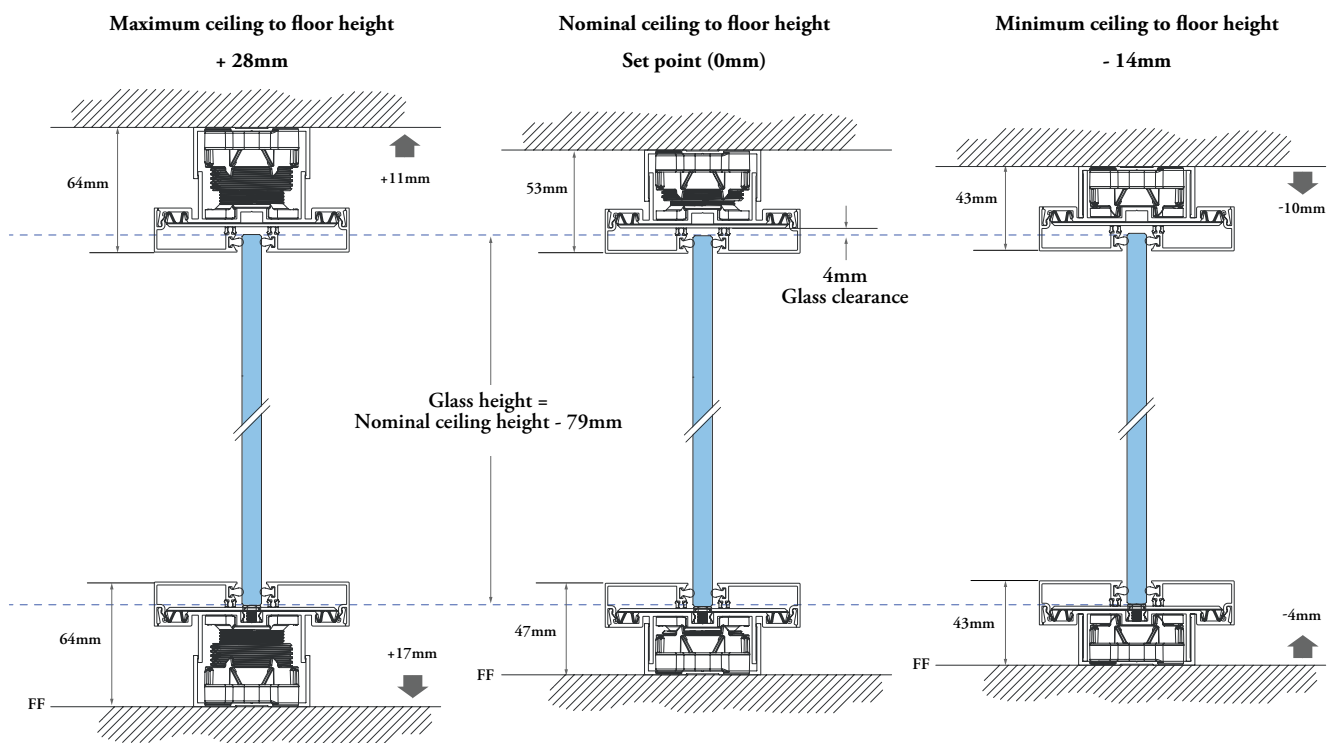

FF = Finished floor

planning with horizontal frames (continued)

The following describes how to specify cuts for horizontal frames. The cut angle and orientation is determined from the side designated as external. Cuts are specified independently on both sides of each frame assemblies.

Join Condition	Diagram	Cut Specification	Restrictions
Inline	<p>A B External Side</p>	<p>A: Right Cut, Angled, 90° B: Left Cut, Angled, 90°</p>	The frame cut must be on module with the fascias.
Two-way corner (90° Corner)	<p>A B External Side</p>	<p>A: Right Cut, Angled, 135° B: Left Cut, Angled, 45°</p>	The frame cut must be on module with the fascias.
Three-way corner (Centered)	<p>C A B External Side</p>	<p>A: Right Cut, Three Way, 135° B: Left Cut, Three Way, 45° C: Four Way, 0°</p>	The frame cut must be on module with the fascias.
Three-way corner (Off-set)	<p>C A B External Side</p>	<p>A: Right Cut, Three Way 120° B: Left Cut, Three Way 60° C: Offset Mitered 0°</p>	The frame cut must be on module with the fascias.
Variable angle	<p>W A B External Side</p>	<p>W= 110° - 170° (10° increments) A = Right Cut, Angled, [180°-(W÷2)] B = Left Cut, Angled, [W÷2]</p>	The frame cut must be on module with the fascias.

glass fascias &
connectors

glass fascias & connectors

UNDERSTANDING FASCIAS	39
GLASS FASCIA BASICS	40
PLANNING WITH GLASS FASCIAS	41
GLASS CONNECTOR BASICS	44
PLANNING WITH GLASS CONNECTORS	45

Focus fascias are available in glass.

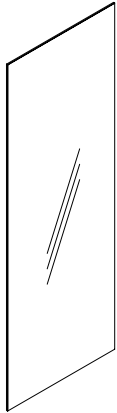

glass

Glass fascias are ideal when light transmission is required through adjacent rooms and building spaces.

Single or double glazing can be specified depending on the acoustic requirements of the space.

glass fascia basics

Glass fascias create the faces of Focus walls.

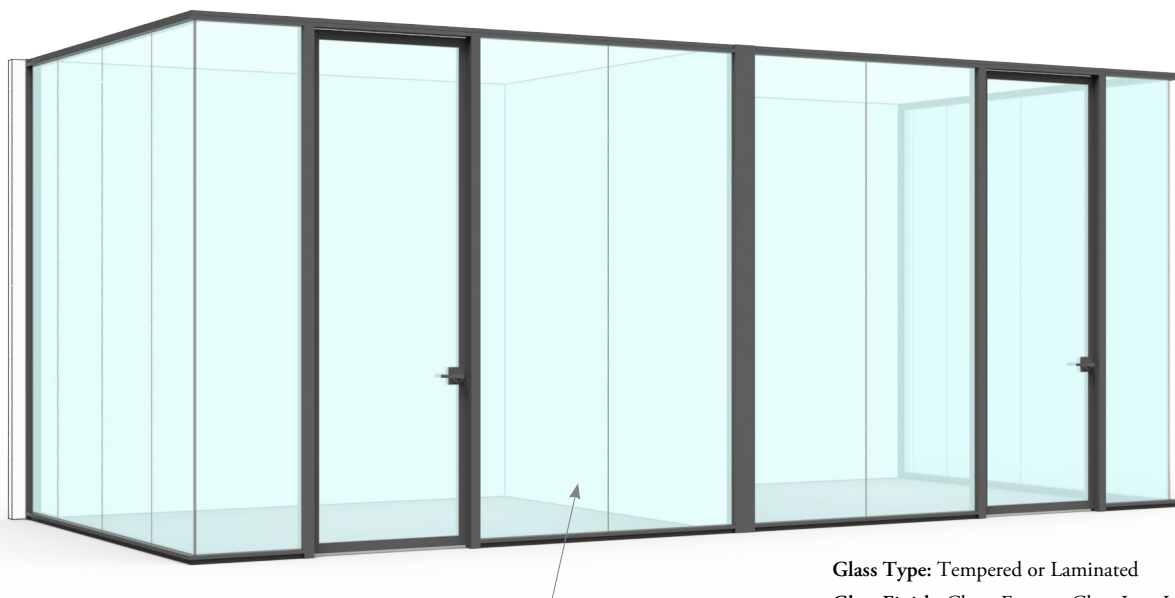

Glass Fascia – 10mm Thickness (MFWGA) and
Glass Fascia – 12mm Thickness (MFWGB)

Glass Type: Tempered or Laminated
Glass Finish: Clear, Frost or Clear Low Iron



Glass Fascia – 10mm Thickness (MFWGA) and
Glass Fascia – 12mm Thickness (MFWGB)

- Monolithic glass fascias
- Two glass edge styles are available
 - straight on both sides
 - mitered on one side and straight on the other

planning with glass fascias

The following outlines the available sizes for Focus fascias.

Fascia height and width sizes shown are nominal with the ability to specify to 1/16" (1.6mm) increments.

glass fascias

Ceiling height:

81" - 120" for tempered and laminate
10mm and 12mm

Glass width:

12" - 36" for 10mm

12" - 48" for 12mm

Maximum run:

24' for 10mm

36' for 12mm



Center glass



Offset glass

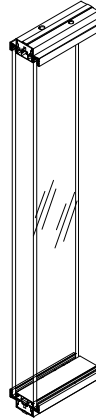

Double glass

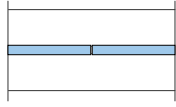
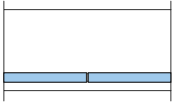
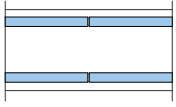
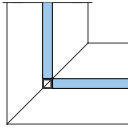
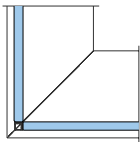
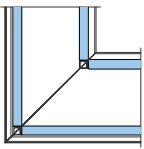
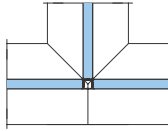
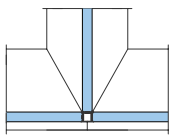
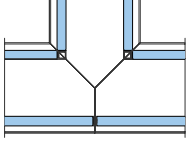
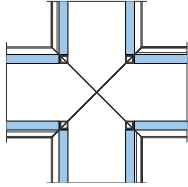
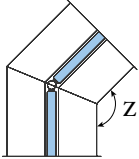
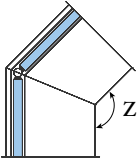
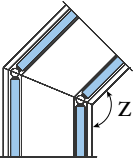

planning with glass fascias (continued)

The following demonstrates the variety of glass fascias that are available.

	Center glass	Offset glass	Double glass
Inline			
Two-way corner (90° corner)			
Three-way corner			
Four-way corner			
Variable angle Z: 110-170° 10° increments			

planning with glass fascias (continued)

The following should be considered when planning with glass fascia connections.

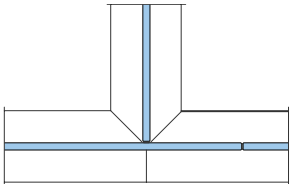
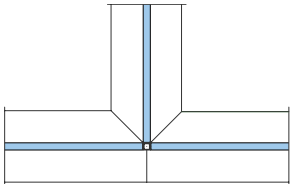
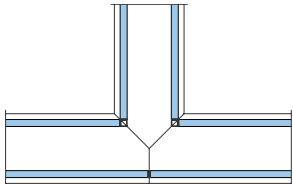
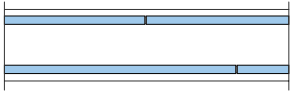
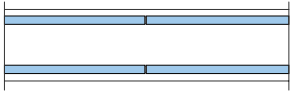
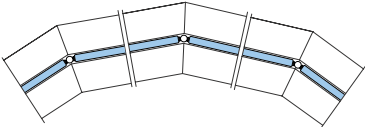
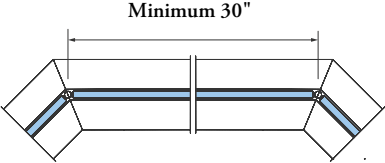
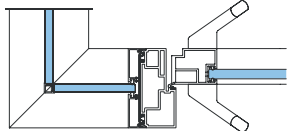
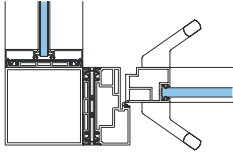
	Restriction 	Solution 1 	Solution 2 
Three-way connections	 <p>Three-way corner connections cannot be planned off-module in center glass configurations.</p>	 <p>Three-way corner connections can be achieved using on-module center glass.</p>	 <p>Three-way on-module connection can also be achieved using double glass.</p>
In-line connectors	 <p>Inline double glass connections cannot be off module.</p>	 <p>On-module inline double glass connections can be used.</p>	
Variable connections	 <p>The variable connector should not be used to create a glass wall of multiple small facets.</p>	 <p>Minimum 30"</p> <p>The variable connector should be used to join long spans of linear glass fascias at angles. Only one glass fascia with two variable angle connectors can be used in the same run.</p>	
Glass fascia widths	 <p>Glass fascia modules cannot be below 12" in width.</p>	 <p>Eliminate small glass fascia modules when possible (must ensure local building code requirements allow in door applications).</p>	

glass connector basics

Focus offers a variety of connectors for glass to glass connections that are available in aluminum, polycarbonate or tape options to provide a refined aesthetic.

Frame finishes: Clear Anodized
Glass Connection finishes: Clear Anodized

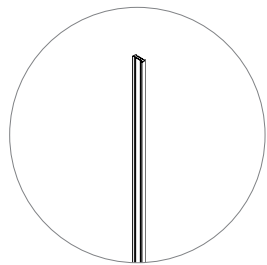
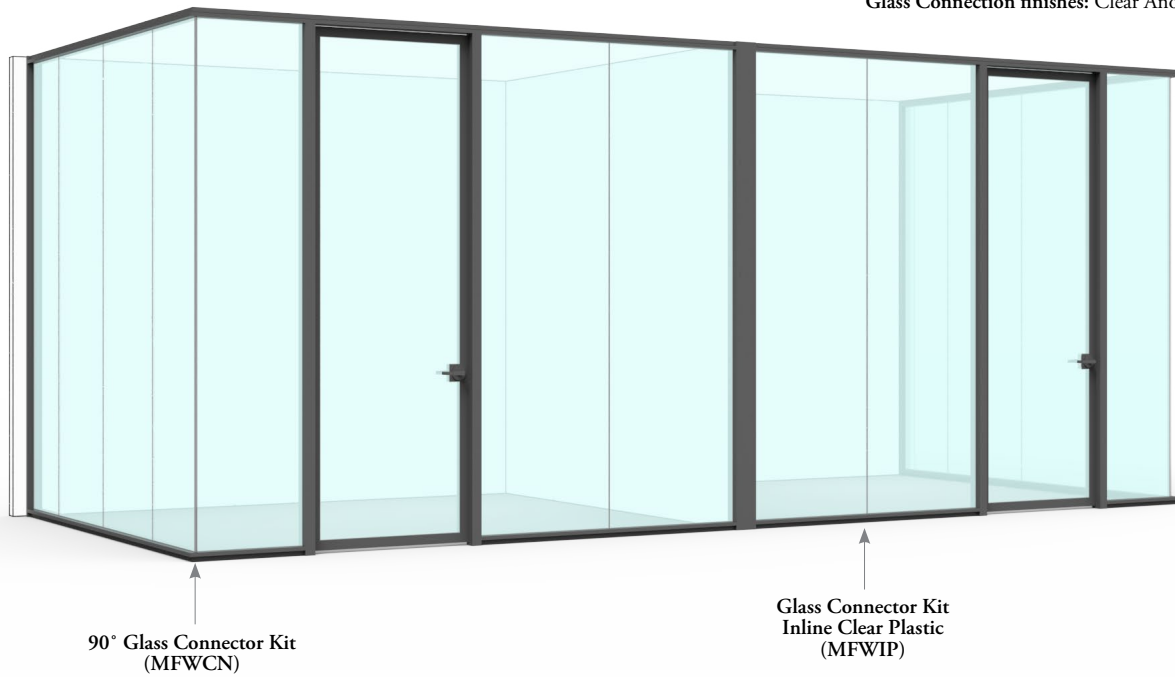

Glass Connector Kit Inline Clear Plastic (MFWIP)
Available for 10mm and 12mm glass

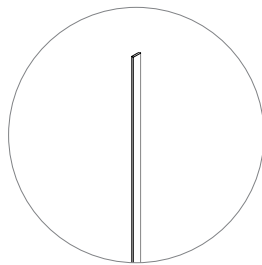

Glass Connector Kit Inline Tape (MFWIT)
Available for 10mm and 12mm glass

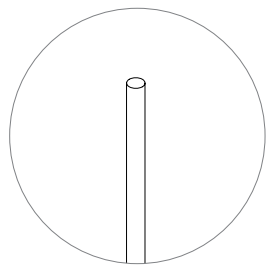

Glass Connector Kit - Variable Angle Clear Plastic (MFWVP)
• Available for 10mm and 12mm glass

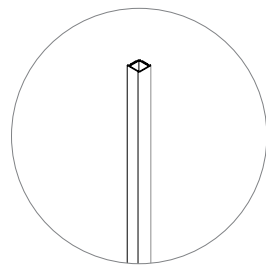

90° Glass Connector Kit (MFWCN)
• Corner Connection types available include tape and plastic tube
• Available for 10mm and 12mm glass

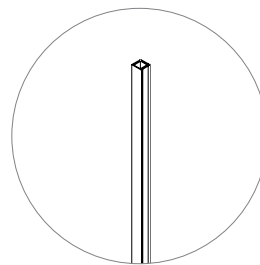

Three-Way Glass Connector Kit (MFWCT)
• Corner Connection types available include tape and plastic tube
• Available for 10mm and 12mm glass

planning with glass connectors

The following outlines the options available for connecting glass fascias.

When specifying glass connections the following should be considered:

- There is only one inline connection type per run
- Corner and variable angle connections can be specified separately

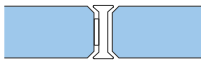
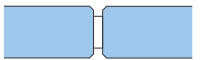
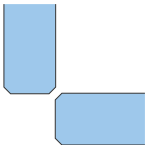
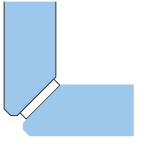
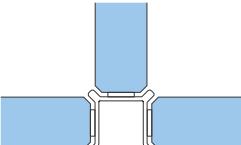
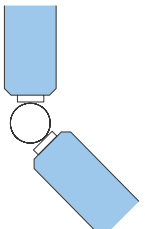
	Aluminum joined with tape	Clear plastic joined with tape	Tape
Inline		 <p>Glass Connector Kit Inline Clear Plastic (MFWIP)</p>	 <p>Glass Connector Kit Inline Tape (MFWIT)</p>
Two-way (90° corner)		 <p>90° Glass Connector Kit (MFWCN)</p>	 <p>90° Glass Connector Kit (MFWCN)</p>
Three-way corner		 <p>Three-Way Glass Connector Kit (MFWCT)</p>	
Variable angle	 <p>Glass Connector Kit - Variable Angle Clear Plastic (MFWVP)</p>		

doors

doors

UNDERSTANDING DOORS	48
PIVOT DOOR & FRAME BASICS	49
PLANNING WITH PIVOT DOORS	51
SLIDING DOOR BASICS	53
PLANNING WITH SLIDING DOORS	54
HINGED DOOR & FRAME BASICS	61
PLANNING WITH HINGED DOORS	63
HARDWARE BASICS	65
PLANNING WITH HARDWARE	67
WALL DOOR START BASICS	68
PLANNING WITH WALL DOOR STARTS	69

understanding doors

Focus offers a variety of door styles that provide varying aesthetics and acoustic performance.

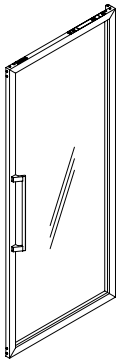

Pivot doors are composed of aluminum framed single or double glass to allow for varying levels of acoustic performance. Pivot mechanisms and hardware are integrated into the frame providing an uninterrupted visual.

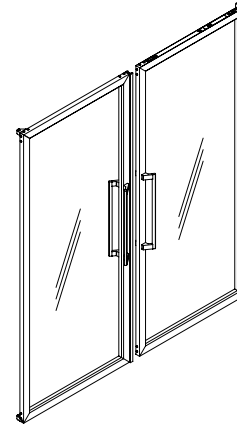

Double pivot doors are similar to single leaf pivot doors and are used for formal entrances or boardroom applications with high traffic flow.

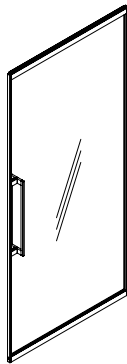

Sliding doors are ideal when floor space efficiency is required. They are center mounted and run parallel to the wall. Doors are composed of a glass panel with a minimal aluminum frame for hardware integration.

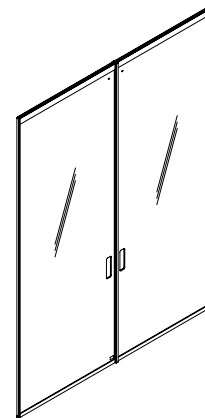

Double sliding doors are ideal for entrances of boardrooms and conference rooms where large door openings are required for higher traffic flow, while maintaining space efficiency.

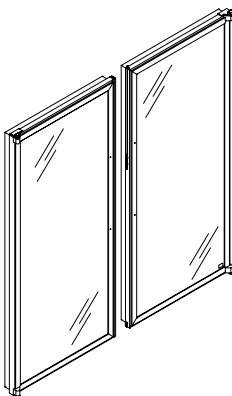

Double Leaf Solid Hinged Door and Double Leaf Double Glazed Pivot Door. Double hinged doors are similar to single hinged doors and are used for formal entrances or boardroom applications with high traffic flow. Hinge mechanisms and hardware are exposed.

pivot door & frame basics

Pivot doors are a framed glass door with concealed hardware that provides an uninterrupted aesthetic to a Focus wall.

- Available in nominal heights from 84" – 120" with the ability to specify in 1" increments
- Available with or without a door drop seal to allow for additional acoustic
- Available with or without a closer and hold-open
- Available left or right handed
- Available cut conditions include no strike for a pull or with strike for a lever or cylindrical lock
- Available with Tempered or Laminated glass type
- Available with Frost, Clear or Clear Low Iron glass finish

Single Leaf Pivot Door Frame (MFWSPDJ)

Single Leaf Single Glazed Pivot Door (MFWSGPL) with Schlage series door hardware (MFWDHXS/MFWDHNS)

For hardware options and finishes refer to the chart on the Planning with Hardware page in this section.

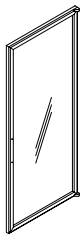

Single Leaf Single Glazed Pivot Door (MFWSGPL)

- A framed pivot door with a 45mm frame and a single 12mm glass panel
- Available in 40" and 42" nominal widths with clear openings of 34-1/4" (870mm) and 36-1/4" (921mm) respectively
- Opening with Closer 110°, without closer 160°
- Doors without Closer will be supplied with Magnetic Door Stop
- Doors with Closer will be supplied with Round Door Stop
- Roller latch is always included with the soft close and selected handle type
- Roller latch catch plate is painted according to frame finish
- In reversed application, the door stop will be located in the passage and can therefore be seen as a tripping hazard

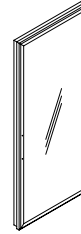

Single Leaf Double Glazed Pivot Door (MFWSOPL)

- A pair of framed pivot door with a 100mm frame, 6mm inner and 10mm outer glass panels, 6mm glass is always Tempered
- Available in 40" and 42" nominal widths with clear openings of 32-1/16" (815mm) and 34-1/16" (866mm) respectively
- Opening with Closer 110°, without closer 160°
- Doors without Closer will be supplied with Magnetic Door Stop
- Doors with Closer will be supplied with Round Door Stop
- Roller latch is always included with the soft close and selected handle type
- Roller latch catch plate is painted according to frame finish
- In reversed application, the door stop will be located in the passage and can therefore be seen as a tripping hazard

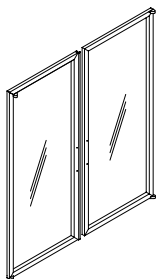

Double Leaf Single Glazed Pivot Door (MFWDGPL)

- A pair of framed double pivot doors with a 45mm frame and single 12mm glass panel
- Right hand door is always active, left door is inactive
- Available in 78" and 84" nominal widths with clear openings of 67-1/4" (1709mm) and 73-1/4" (1861mm) respectively
- Opening with Closer 110°, without closer 160°
- Doors without Closer will be supplied with Magnetic Door Stop
- Doors with Closer will be supplied with Round Door Stop
- Due to the astragal, holes are visible at the top and bottom of the door
- Roller latch is always included with the soft close and selected handle type
- Roller latch catch plate is painted according to frame finish
- In reversed application, the door stop will be located in the passage and can therefore be seen as a tripping hazard

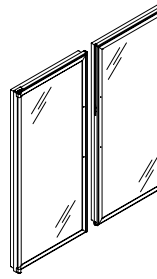

Double Leaf Double Glazed Pivot Door (MFWDOPL)

- A pair of framed double pivot doors with a 100 mm frame, 6mm inner and 10mm outer glass panels, 6mm glass is always Tempered
- Right hand door is always active, left door is inactive
- Available in 78" and 84" nominal widths with clear openings of 67-1/4" (1709mm) and 73-1/4" (1861mm) respectively
- Opening with Closer 110°, without closer 160°
- Doors without Closer will be supplied with Magnetic Door Stop
- Doors with Closer will be supplied with Round Door Stop
- Due to the astragal, holes are visible at the top and bottom of the door
- Roller latch is always included with the soft close and selected handle type
- Roller latch catch plate is painted according to frame finish
- In reversed application, the door stop will be located in the passage and can therefore be seen as a tripping hazard

pivot door & frame basics (continued)

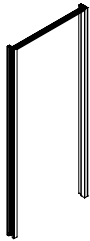

Single Leaf Pivot Door Jamb Kit (MFWSPDJ)

- Available for double and single glazed pivot doors
- Consists of two vertical jamb extrusions
- Available in nominal widths of 40" and 42"

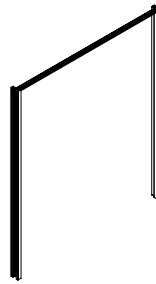

Double Leaf Pivot Door Jamb Kit (MFWDPDJ)

- Frame for single glazed pivot door, double frame consists of two vertical jamb extrusions
- Available in nominal widths of 78" and 84"

planning with pivot doors

The following outlines the features of pivot doors.

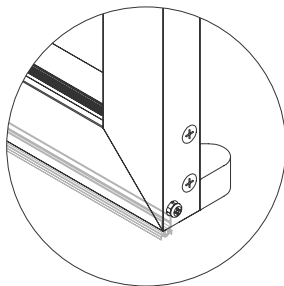
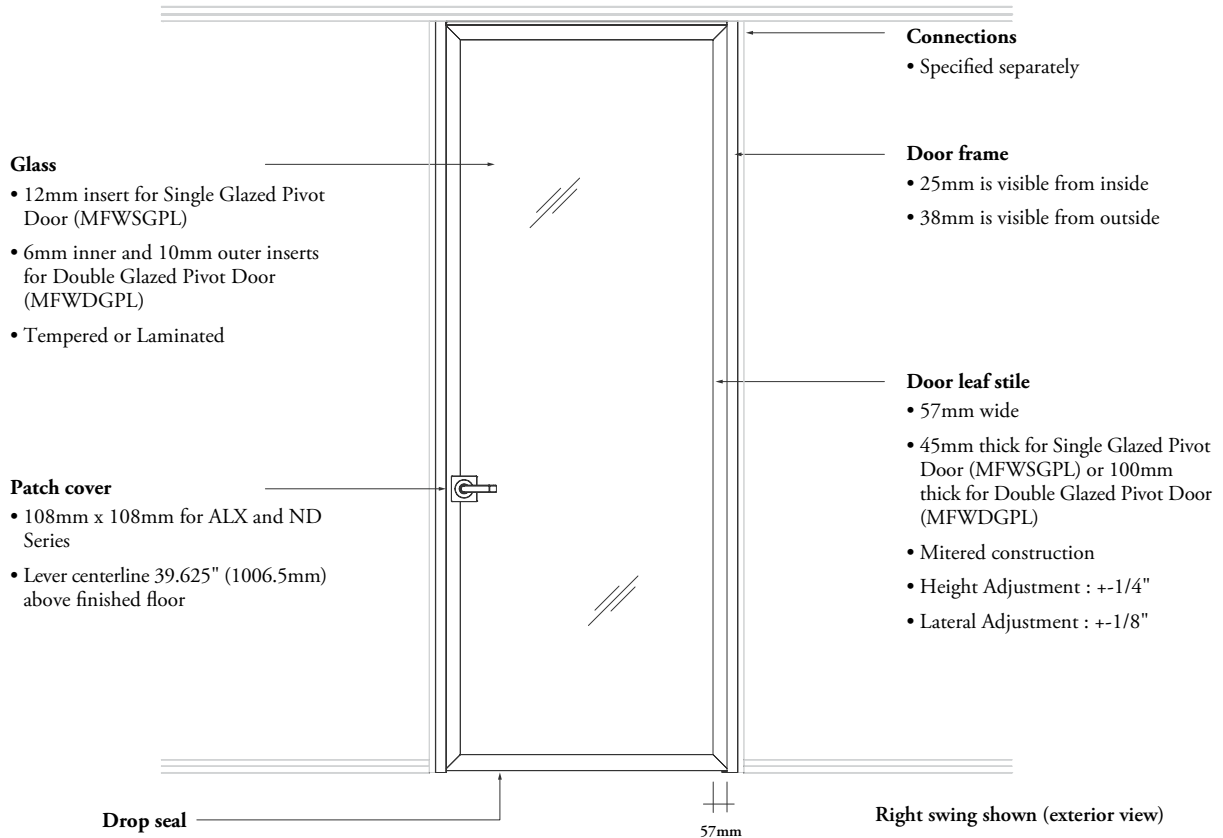

Drop seal

- Actuator pin drops seal when door is closed against jamb and allows for additional acoustics
- Maximum drop of 20mm
- Casing finished in Clear Anodized only

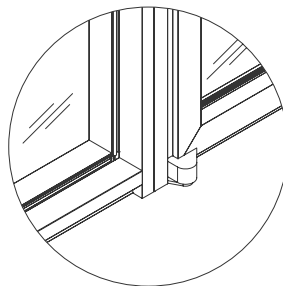

Pivot mechanism (interior view)

- One pivot on top of door and one on bottom
- Finished to match frame

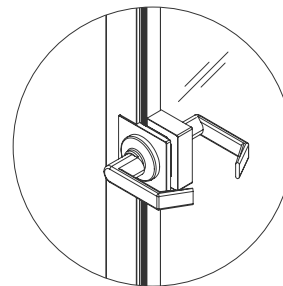

Patch cover (exterior view)

- Aluminum construction
- No exposed fasteners
- Finished to match frame

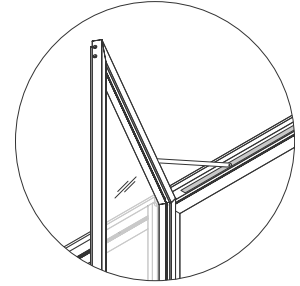

Door closer

- Optional
- Concealed closer
- Adjustable closing speed
- Closer arm finished to match frame
- Hold Open feature is included with the Closer Mechanism
- Maximum 110° opening range

planning with pivot doors (continued)

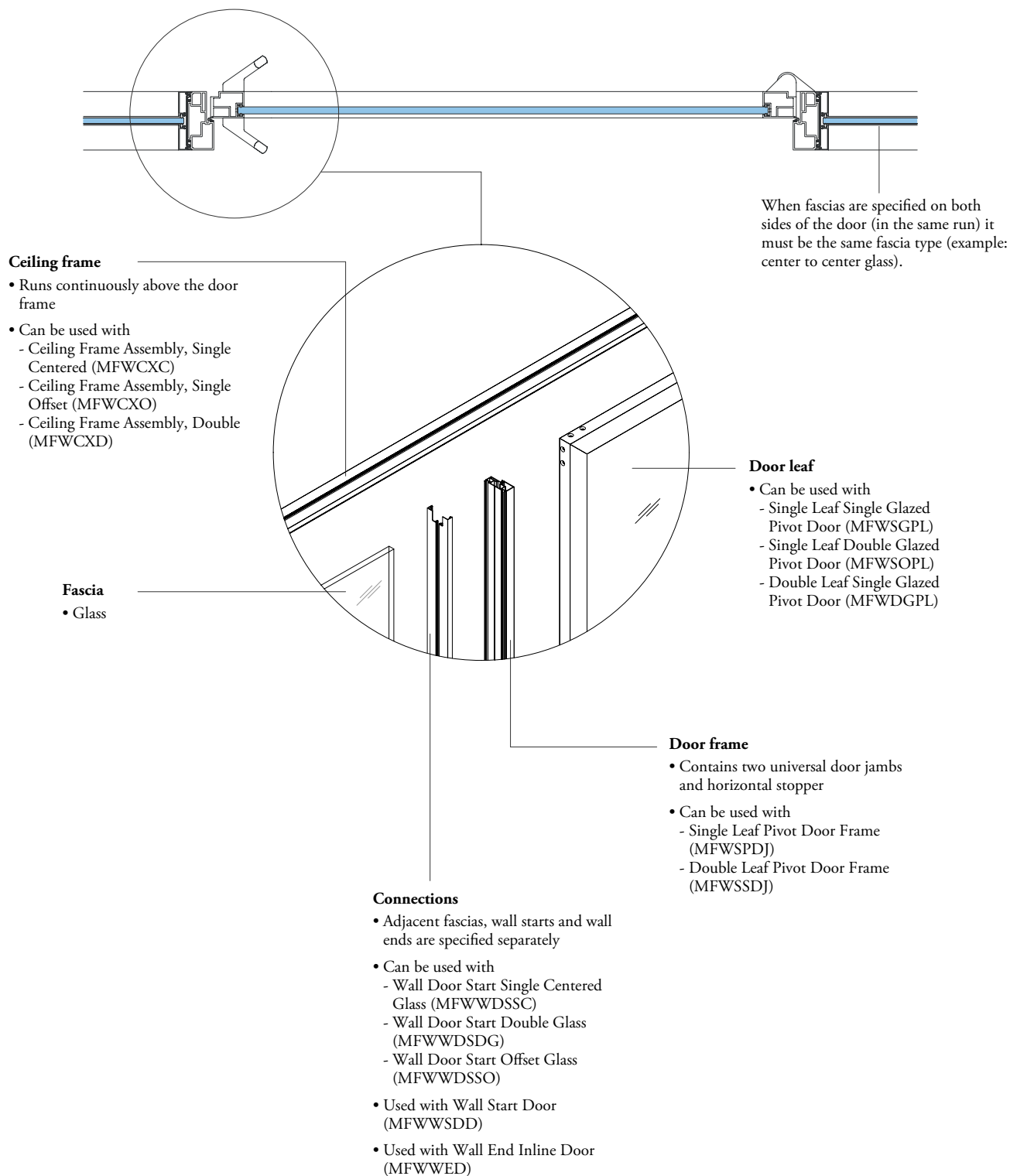

Sliding doors provide a space saving solution by running parallel to the wall. The sliding door frame can be integrated into adjacent horizontal frames for a continuous storefront aesthetic.

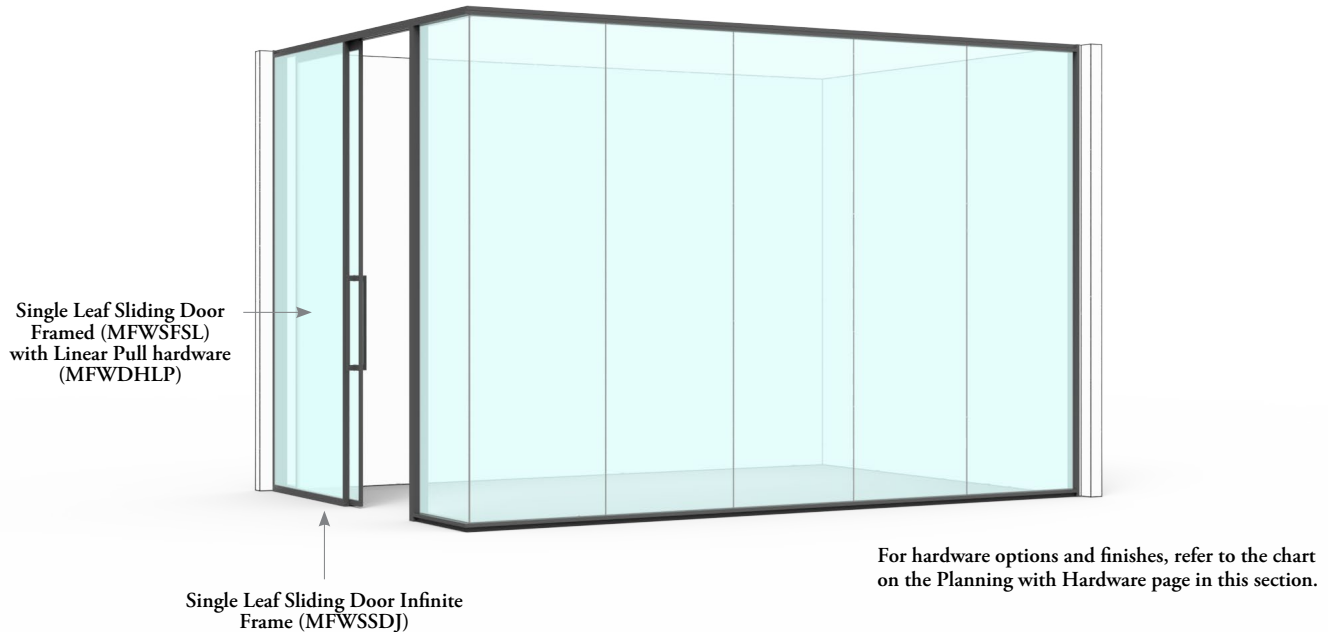

Single Leaf Sliding Door Framed (MFWSFSL)

- A framed sliding door with a 26mm thick frame and a single 10mm glass panel
- Available for ceiling heights 84" – 120" in 1/16" increments
- Available with a left or right door slide
- Available with or without drop seal
- Available in 40" and 42" nominal widths with clear openings of 34" (863mm) and 36" (914mm) respectively
- Available with Tempered or Laminated glass
- Available with Frost, Clear or Clear Low Iron glass finish

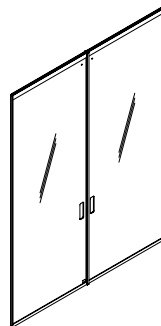

Double Leaf Sliding Door Framed (MFWDFSL)

- A framed sliding door with a 26mm thick frame and a single 10mm glass panel
- Available with or without drop seal
- Available in 78" and 84" nominal widths with clear openings of 66 3/4" (1696mm) and 72 3/4" (1848mm) respectively
- Available with Tempered or Laminated glass
- Available with Frost, Clear or Clear Low Iron glass finish

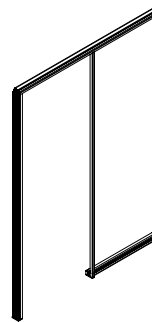

Single Leaf Sliding Door Infinite Frame (MFWSSDJ)

- Frame consists of top and base sliding rail, front and back jamb
- Can be spliced into standard horizontal frames
- Available with configurable rail length of 80" – 95-15/16" wide
- Available for double and single glazed sliding doors (Glass Fascias (MFWGA/MFWGB) must be specified separately)
- Includes soft open / soft close mechanism as standard

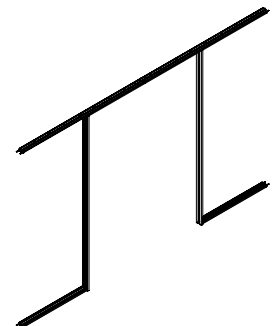

Double Leaf Sliding Door Infinite Frame (MFWSDSJ)

- Frame consists of top and base sliding rail, front and back jamb
- Can be spliced into standard horizontal frames
- Available with configurable rail length of 78" – 95-15/16" wide
- Available for double and single glazed sliding doors (Glass Fascias (MFWGA/MFWGB) must be specified separately)
- Includes soft open / soft close mechanism as standard

planning with sliding doors

The following outlines the features of sliding doors.

Both locking and non-locking versions of the sliding door are available. Doors are handed and the handedness is determined by the direction that the door slides.

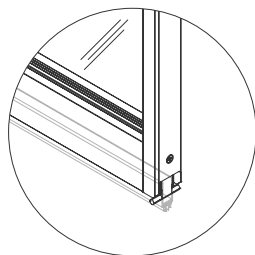
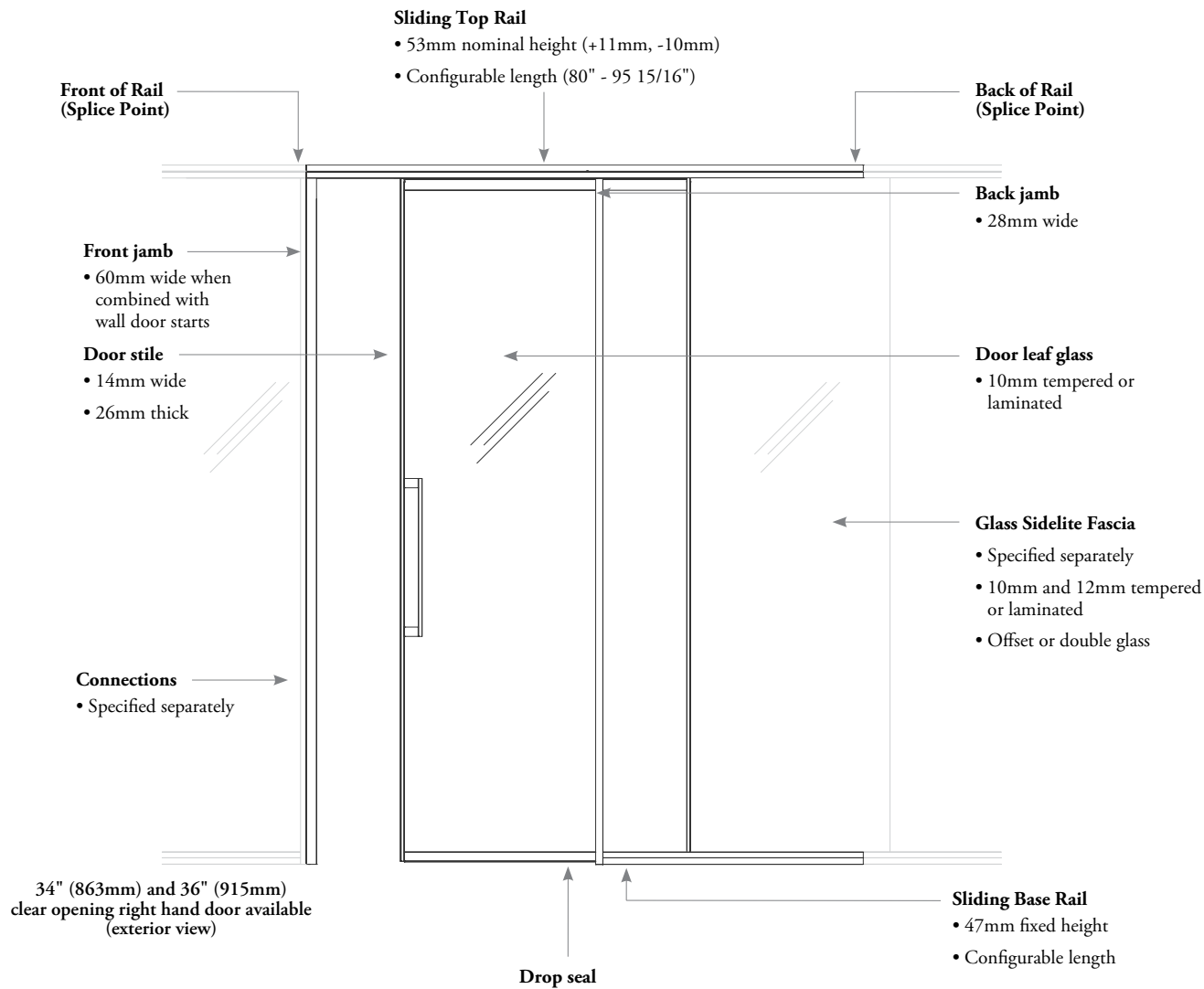

Drop seal

- Actuator lever drops seal in closed position
- Maximum drop of 18mm
- Casing finished in Clear Anodized only

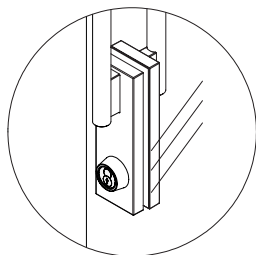

Patch cover (exterior view)

- Die cast construction
- No exposed fasteners
- Finish to match frame

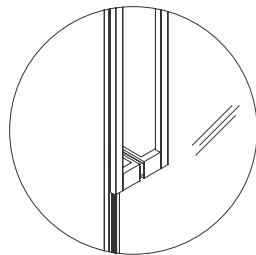

Pull

- Aluminum construction
- Adhered with tape
- Proportions match door stile

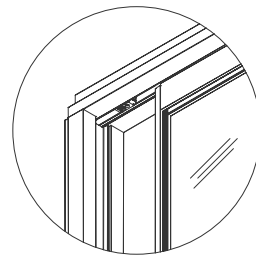

Soft close roller

- Standard offering
- +/- 3mm of leveling
- Center mounted on frame

planning with sliding doors (continued)



Horizontal Frames

- Adjacent horizontal frames can be planned in two ways:
 1. Spliced into the sliding rail (same run)
 2. Separate from the sliding rail (break in run)
- The following frame types can be spliced into the front of the sliding rail:
 - Ceiling Frame Assembly, Single Centered (MFWCXC)
 - Ceiling Frame Assembly, Single Offset (MFWCXO)
 - Ceiling Frame Assembly, Double (MFWCXD)
- The following frame types can be spliced into the back of the sliding rail:
 - Ceiling Frame Assembly, Single Offset (MFWCXO)/Base Frame Assembly, Single Offset (MFWBXO)
 - Ceiling Frame Assembly, Double (MFWCXD)/Base Frame Assembly, Double (MFWBCXD)
- Any frame type can be applied on either side when separated from the sliding rail (break in run)

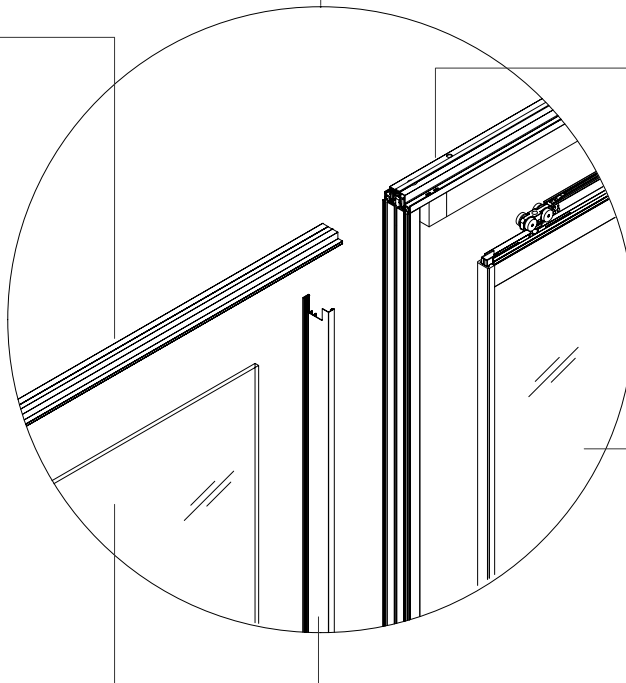

Sliding Door Frame

- Single Leaf Sliding Door Infinite Jamb Kit (MFWSSDJ)
- Double Leaf Sliding Door Infinite Jamb (MFWDSJ)
- Frame consists of top and base sliding rail, front and back jamb

Sliding Door Leaf

- Framed Single Leaf Single Glazed Sliding Door (MFWSFSL)
- Framed Double Leaf Single Glazed Sliding Door (MFWDFSL)

Fascias

- The following fascias can be applied directly to the front of the sliding rail:
 - Glass Fascia – 10mm Thickness (MFWGA)
 - Glass Fascia – 12mm Thickness (MFWGB)
- The following fascias can be applied directly to the back of the sliding rail:
 - Glass Fascia – 10mm Thickness (MFWGA)
 - Glass Fascia – 12mm Thickness (MFWGB)

Connections

- The following can be applied directly to the front of the sliding rail:
 - Wall Door Start Single Centered Glass (MFWWDSSC)
 - Wall Door Start Double Glass (MFWWDSDG)
 - Wall Door Start Offset Glass (MFWWDSSO)
 - Wall Start Door (MFWWSDD)
 - Wall End Inline Door (MFWWED)
- The following can be applied directly to the back of the sliding rail:
 - Wall Start Single Offset Glass (MFWWSSO)
 - Wall Start Double Glass (MFWWSDG)
 - Wall End Inline Offset Glass (MFWWESO)
 - Wall End Inline Double Glass (MFWWEDG)

planning with sliding doors (continued)

The following should be considered when planning with sliding doors.

<p>The glass sidelite fascia can be off-module from the splice point, depending on the specific run length. Glass is optimized to be same width.</p>		
<p>The glass sidelite fascia can be on-module from the splice point, depending on the specific run length. Glass is optimized to be same width.</p>		
<p>The sliding rail cannot be spliced directly to create a corner joint (90°, Three-Way, Four-Way) or variable angle.</p>		
<p>The sliding rail can be spliced to create an inline joint. An adjacent horizontal frame is required to create a corner joint (90°, Three-Way, Four-Way) or variable angle. The adjacent horizontal frame must be 12" minimum in length.</p>		

planning with sliding doors (continued)

A horizontal frame cannot be spliced to the back of a door rail when the run length is between the following dimensions:

- 40" (1016mm) nominal doors: 80" (2032mm) – 91-15/16" (2335mm)
- 42" (1067mm) nominal doors: 84" (2134mm) – 95-15/16" (2437mm)

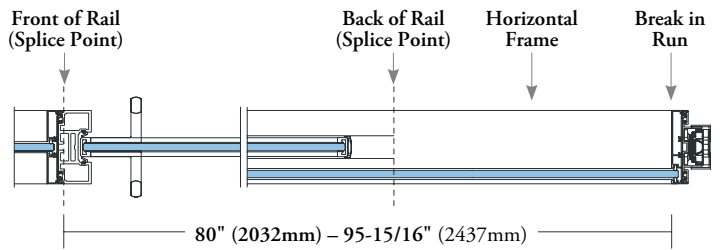

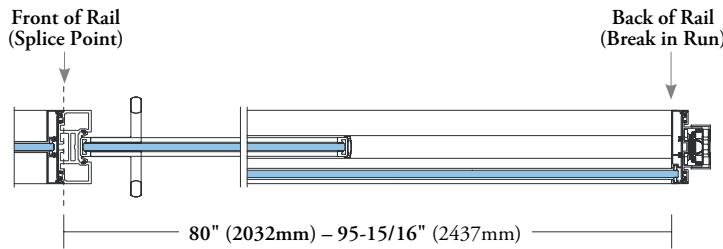

The sliding rail length must be configured when the overall run length is between 80" (2032mm) – 95-15/16" (2437mm).

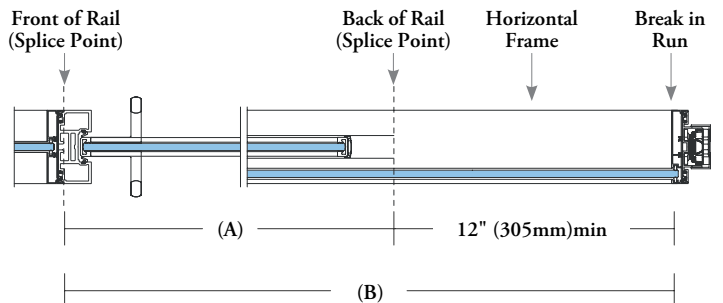

Use the minimum configurable rail length:
 (A) 80" (2032mm) for 40" (1016mm) door widths, when the overall run length is (B) 92" (2337mm) or greater.
 (A) 84" (2134mm) for 42" (1067mm) door widths, when the overall run length is (B) 96" (2438mm) or greater.



planning with sliding doors (continued)

<p>The back rails of two sliding door frames can be adjacent to each other if required.</p>		
<p>The back and front rail of two sliding door frames cannot be spliced directly.</p>		
<p>The back and front rails of two sliding door frames can be spliced with a section of horizontal framing. The horizontal frame must be 12" (305mm) minimum in length.</p>		
<p>The back and front rails of two sliding door frames can be separated with a break in run.</p>		

planning with sliding doors (continued)

double leaf

A horizontal frame cannot be spliced to the back of a double leaf door rail when the run length is between the following dimensions:

- 78" (1981mm) nominal doors: 156" (3962mm) – 179-7/8" (4569mm) (78" (1981mm) – 89-15/16" (2284mm) to center)
- 84" (2137mm) nominal doors: 168" (4267mm) – 191-7/8" (4873mm) (84" (2133mm) – 95-15/16" (2437mm) to center)

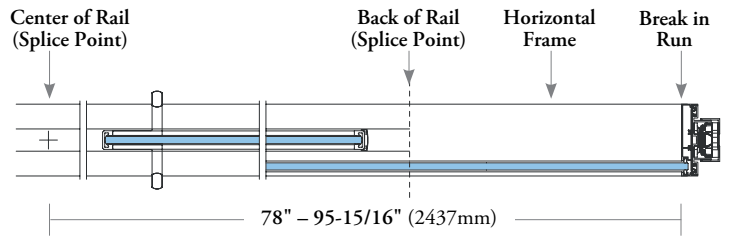

The double leaf sliding rail length must be configured when the overall run length is between 156" (3962mm) – 191 7/8" (4873mm) (78" (1981mm) - 95 15/16" (2437mm) to center)

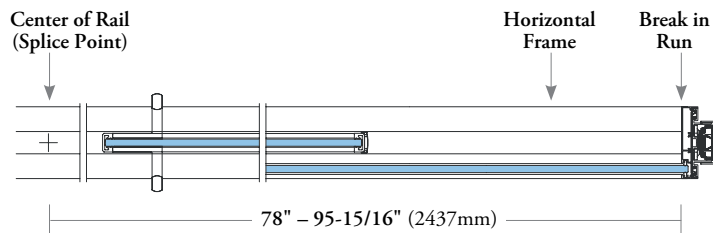

Use the minimum configurable rail length for double sliding doors when:

(A) 78" (1981mm) to center for 78" (1981mm) nominal door widths, when the run length is (B) 90" (2286mm) to center (180" (4572mm) overall) or greater

(A) 84" (2133mm) to center for 84" (2133mm) door widths, when the run length is (B) 96" (2438mm) to center (192" (4876mm) overall) or greater

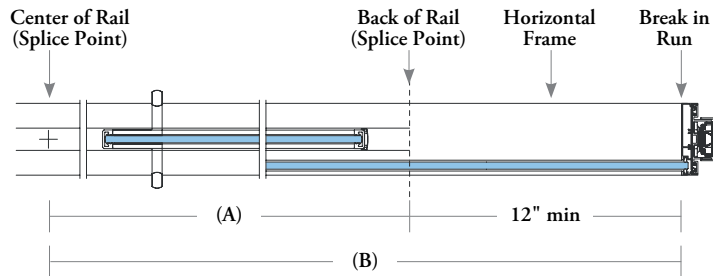

planning with sliding doors (continued)

The following information must be taken into consideration when planning and specifying sliding doors.

- Additional ceiling structure is required to accommodate the top rail of the sliding door. This is due to the absence of a third post in the door frame design
- In drywall ceiling and bulkhead conditions, the structure above the ceiling is the responsibility of the General Contractor and must be installed in advance
- Below is a general diagram of the type of structure required. Note specific structural requirements will be dependent on each building condition. Review with a Teknion representative if required

drywall ceiling with wood structure

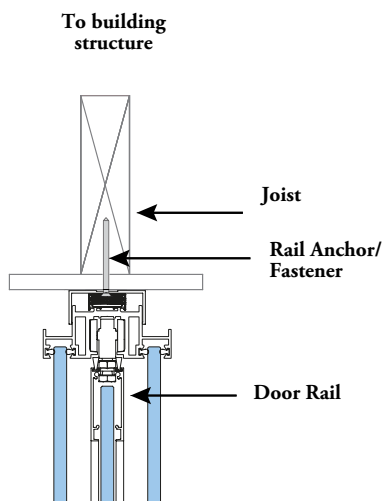

suspended ceiling with steel framing

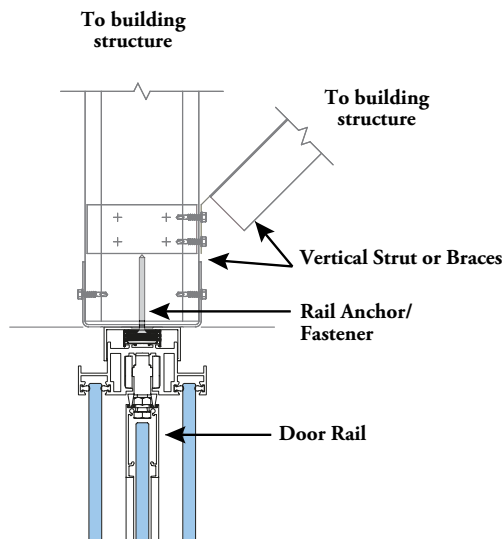

suspended ceiling with steel framing and cables

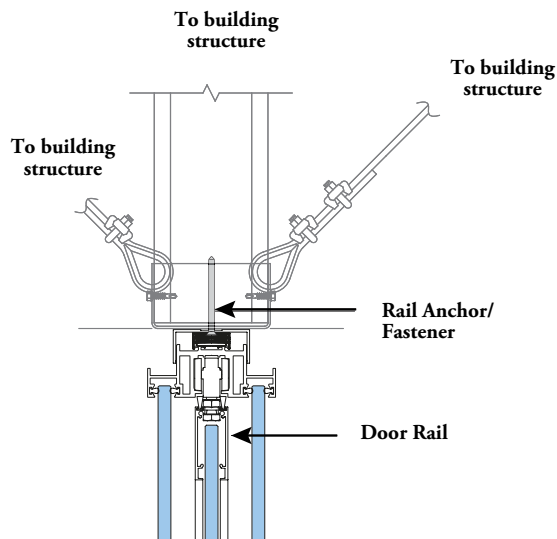

hinged door & frame basics

Focus hinged doors are frameless and are available in glass or wood.

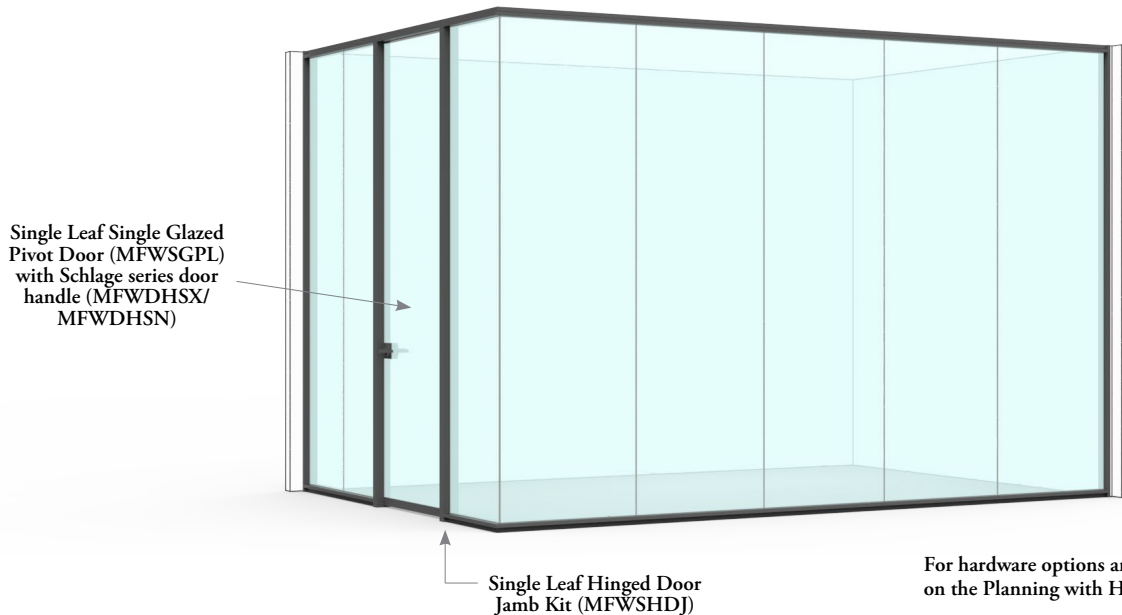

For hardware options and finishes, refer to the chart on the Planning with Hardware page in this section.

- Available in nominal heights from 84" - 120" with the ability to specify in 1" increments
- Frame width is 40" or 42" nominal
- Available with left or right door swing
- Available cut conditions include no strike for a pull or with strike for a lever
- Available with or without door drop seal

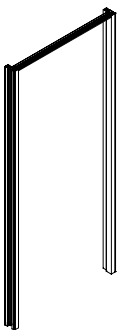

Single Leaf Hinged Door Jamb Kit (MFWSHDJ)

- Frame for hinged door consists of two vertical jambs
- Available in nominal widths of 40" and 42"

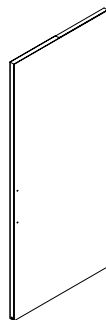

Single Leaf Solid Hinged Door (MFWSSHL)

- Solid wood slab door consists of three hinges
- Available with or without soft close
- Available in 40" and 42" nominal widths with clear openings of 34 7/8" (886mm) and 36 7/8" (937mm) respectively
- Doors without Closer will be supplied with Magnetic Door Stop
- Doors with Closer will be supplied with Round Door Stop
- Roller latch is always included with the soft close and selected handle type
- Roller latch catch plate is painted according to frame finish
- In reversed application, the door stop will be located in the passage and can therefore be seen as a tripping hazard
- Available with or without drop seal

hinged door & frame basics (continued)

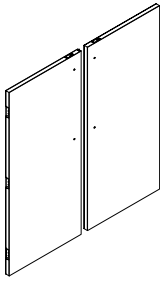

Double Leaf Solid Hinged Door (MFWDSHL)

- Solid wood slab door consists of three hinges
- Available with or without soft close
- Available in 78" and 84" nominal widths with clear openings of 68 5/16" (1750.4mm) and 74 15/16" (1902.8mm) respectively
- Doors without Closer will be supplied with Magnetic Door Stop
- Doors with Closer will be supplied with Round Door Stop
- Available with or without drop seal
- Due to the astragal, holes are visible at the top and bottom of the door
- Roller latch is always included with the soft close and selected handle type
- Roller latch catch plate is painted according to frame finish
- In reversed application, the door stop will be located in the passage and can therefore be seen as a tripping hazard

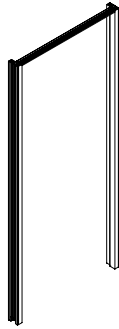

Single Leaf Hinged Door Jamb Kit (MFWSHDJ)

- Frame for Solid Hinged Door consists of two vertical jambs
- Available in nominal widths of 40" and 42"

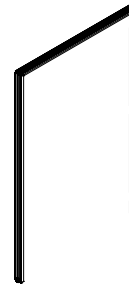

Double Leaf Solid Hinged Door Jamb Kit (MFWDHDJ)

- Frame for Solid hinged door consists of two vertical jambs
- Available in nominal widths of 78" and 84"

planning with hinged doors

The following outlines the features of hinged doors.

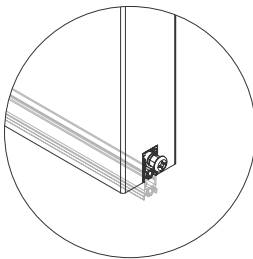
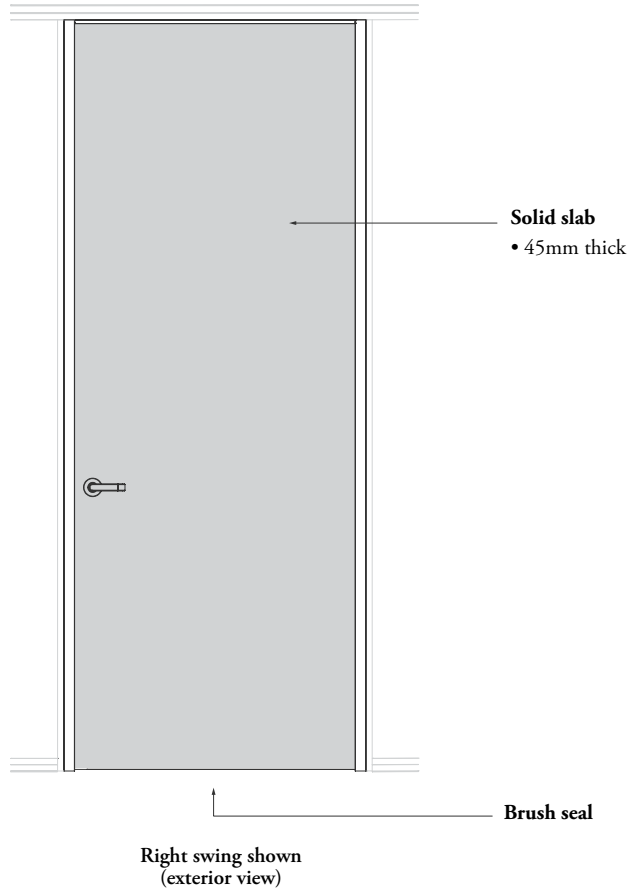

Brush seal

- Optional
- Manually adjustable
- Maximum drop of 14 mm
- Clear Anodized finish

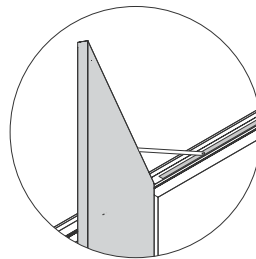

Door closer

- Optional (Solid door only)
- Concealed closer
- Adjustable closing speed
- Closer arm finished to match frame
- Hold Open feature is included with the Closer Mechanism
- Maximum 110° opening range

planning with hinged doors (continued)

The following should be considered when planning with hinged doors.

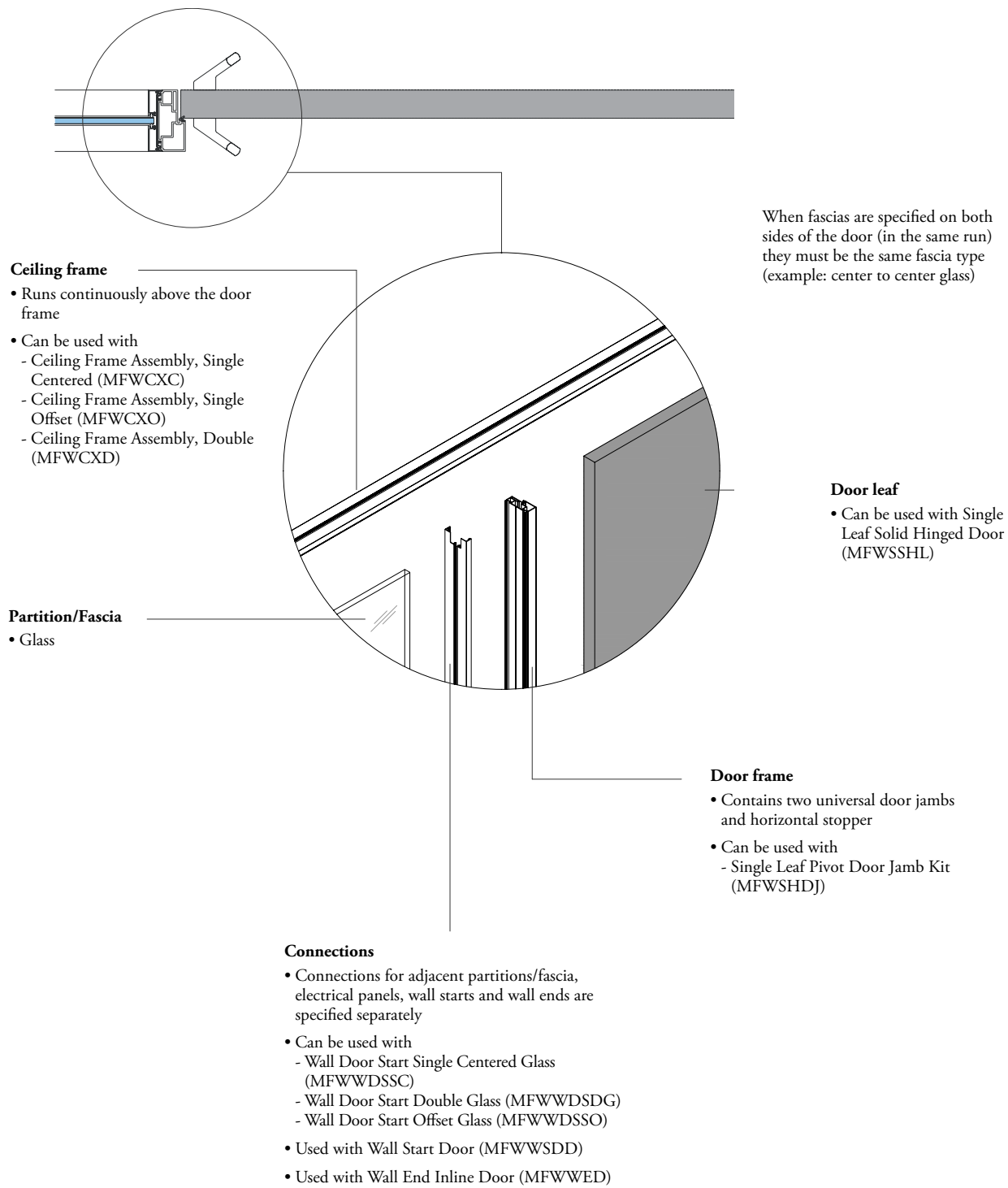

The following outlines the egress hardware available on the hinged, pivot and sliding door programs.

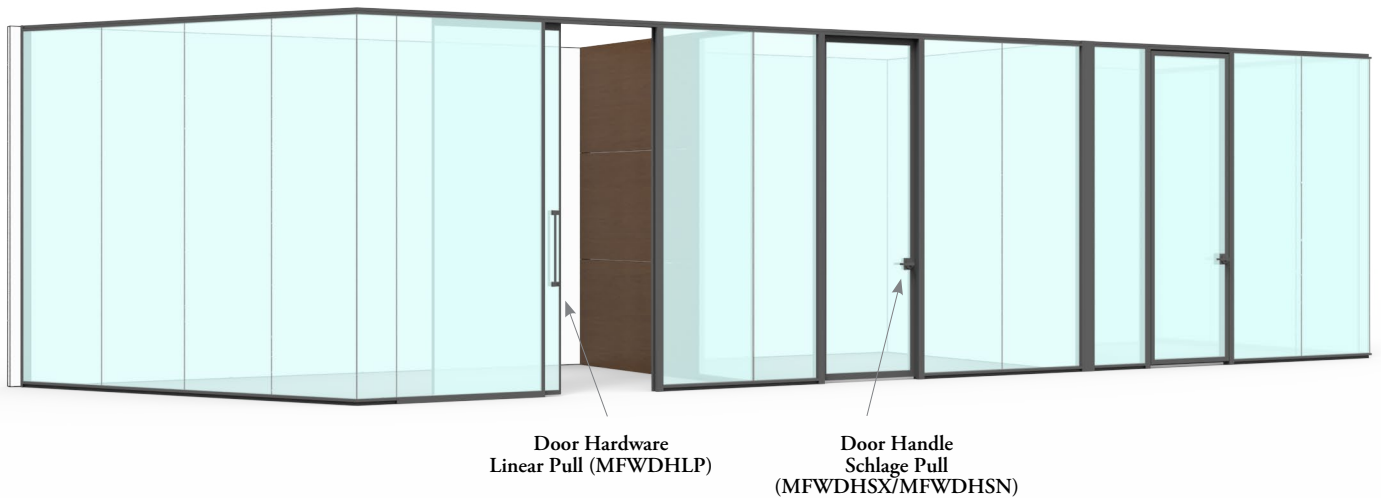

Door Hardware
Linear Pull (MFWDHLP)

Door Handle
Schlage Pull
(MFWDHSX/MFWDHSN)

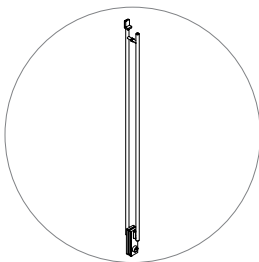

**Door Handle Ladder Pull
(MFWDSCP)**

- Tubular steel pull
- Non-locking: compatible with all doors except double glazed doors
- Locking: compatible with sliding doors only
- Configurable to ceiling heights 84"-120", in 1" increments
- Finishes: Stainless or Painted
- Strike plate color match

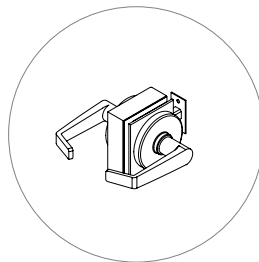

**Door Handle Schlage ALX Series
(MFWDHSX)**

- Cylindrical lock set
- Compatible with hinged and pivot doors only
- Compatible with single glazed and solid leaf
- Non-locking and Locking options
- Lever Finishes: Satin Chrome and Matte Black
- Patch Finishes: Clear Anodized or Painted
- Strike Plate Finish: color coordinated with lever

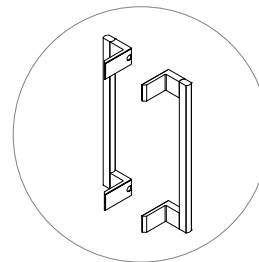

**Door Handle Linear Pull
(MFWDHLP)**

- Square aluminum pull
- Angular Design is compatible with hinged and pivot doors
- Perpendicular Design is compatible with sliding doors
- Compatible with single glazed, double glazed and solid leaf
- Non-locking only
- Lengths: 13" or 24"
- Finishes: Clear Anodized or Painted

hardware basics (continued)

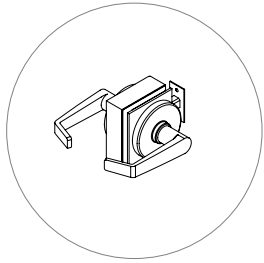

Door Handle Schlage ND Series (MFWDHSN)

- Cylindrical lock set
- Compatible with hinged and pivot doors only
- Compatible with single glazed, double glazed and solid leaf
- Non-locking and Locking options
- Lever Finishes: Satin Chrome and Matte Black
- Patch Finishes: Clear Anodized or Painted
- Strike Plate Finish: color coordinated with lever

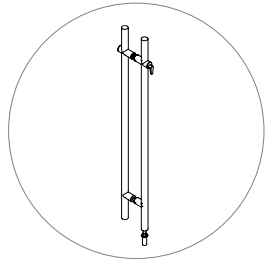



Door Handle Floor Pull (MFWDSFP)

- Tubular steel pull
- Non-locking: compatible with sliding doors only
- Locking: compatible with sliding doors only
- Finishes: Stainless or Painted

planning with hardware

The following describes further details and restrictions of egress hardware available on the hinged, pivot and sliding door programs.

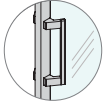
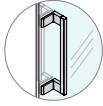
Egress hardware is a configurable kit of parts that is always specified separately from the door leaf.

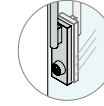
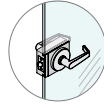
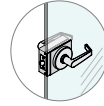
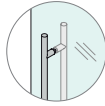
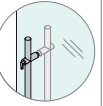
	 Angular	 Perpendicular	 Non-Locking	 Locking (with patch)			 Non-Locking	 Locking
Product Code	MFWDHLP	MFWDSCP	MFWDHSC	MFWDHSL	MFWDHSX	MFWDHSN	MFWDSFP	MFWDSFL
Series	Linear Pull	Ceiling Pull	ALX Series (Cylindrical Lock set)	ND Series	Floor Pull			
Supplier	Teknion	Teknion	Schlage	Schlage	Standard Metal Hardware			
Lever / Pull Type	Square Aluminum Pull	Tubular Steel Pull (1" diameter)	Rhodes Lever	Rhodes Lever	1-3/8" Tubular steel pull Lock integrated in pull			
Swing Door Compatibility	Angular only	Not compatible with double glazed pivot door or locking version	Yes	Yes	No			
Sliding Door Compatibility	Perpendicular only	Yes	N/A	N/A	Yes			
Length Options	13" or 24"	Configurable to ceiling heights 84"-120" in 1" increments	N/A	N/A	48"			
Height AFF	34-5/8" from bottom of pull	Non-Locking: 40-5/16" from bottom of pull (nominal value) Locking: 36-1/2" from CL of cylinder (nominal value)	39-5/8" from CL of lever	39-5/8" from CL of lever	48-1/2" from finished floor to top of pull			
Lock Function Details	Non-Locking only	Locking Option: Keyed outside, manual thumb turn inside	Locking Option: Entrance/Office (keyed outside, push button inside) Non-Locking Option: Passage Latch or Dummy	Locking Option: Entrance/Office (keyed outside, push button inside) Non-Locking Option: Passage Latch or Dummy	Locking option Keyed outside, manual ADA thumb turn Inside			
Code Compliance	ADA compliant	ADA compliant (non-locking only)	ADA compliant	ADA compliant	Not ADA compliant			
Cylinder & Core Details	N/A	Full size interchangeable Core (FSIC) cylinder 6 pin	Full Size Interchangeable Core (FSIC) cylinder 6 pin	Full Size Interchangeable Core (FSIC) cylinder 6 pin	Full Size Interchangeable Core (FSIC) Rim Cylinder			
Lever / Pull Finish Options	Clear Anodized: Can match all standard paint finishes	Stainless: Can match all standard paint finishes	Satin Chrome and Matte Black (strike plate color coordinated with lever)	Satin Chrome and Matte Black (strike plate color coordinated with lever)	Stainless Steel ANSI / BHMA 630, US32D or Painted Matte Black			
Patch Cover Details	N/A	Die cast zinc construction Stainless or Painted	Machined aluminum construction: Clear Anodized or Painted	Machined aluminum construction: Clear Anodized or Painted	N/A			

- Pull finishes should be specified to match door leaf finish
- Patch finishes are driven by door leaf finish
- Doors specified with "interchangeable core cylinder" are keyed randomly (two keys provided per door) but can be removed by a universal control key
- After installation, customers may choose to relocate or replace interchangeable core cylinders to suit their security need

wall door start basics

Focus offers a variety of wall door starts that allow doors to connect to architectural walls.

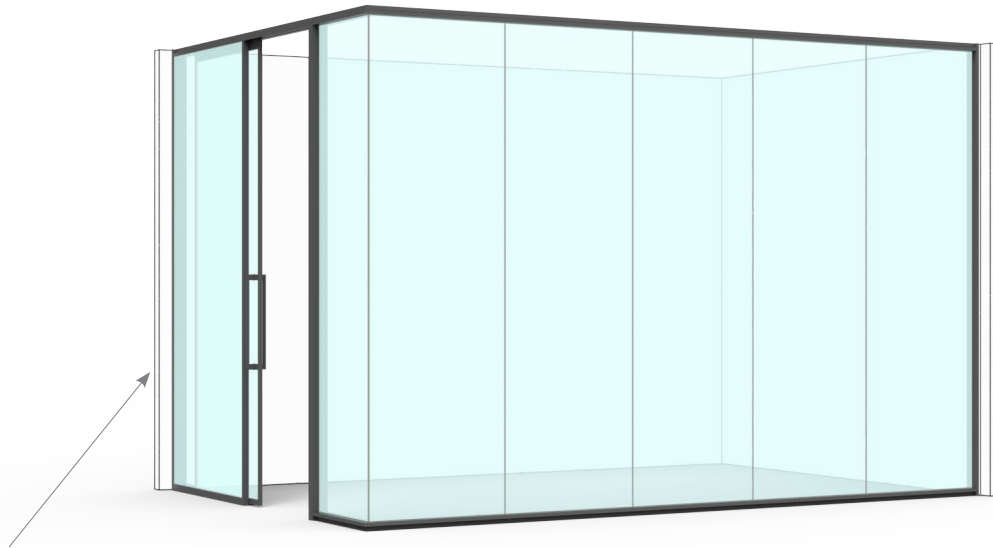

Frame finishes: Clear Anodized and Painted

Wall Door Start
Single Offset Glass
(MFWWDSSO)

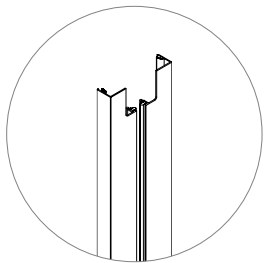

Wall Door Start Single Centered Glass (MFWWDSSC)

Allows for a single center glass monolithic fascia to connect to an adjacent pivot/hinge/sliding door.

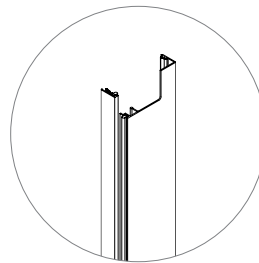

Wall Door Start Offset Glass (MFWWDSSO)

Allows for a single offset glass monolithic fascia to connect to an adjacent pivot/hinge/sliding door.

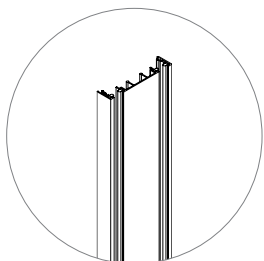

Wall Door Start Double Glass (MFWWDSDG)

Allows for a double glass monolithic fascia to connect to an adjacent pivot/hinge/sliding door.

The following outlines the applications for each wall door start.

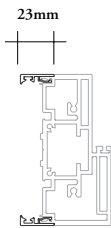

All wall door starts have a nominal depth of 23mm,
Wall start door (MFWWDSG) shown

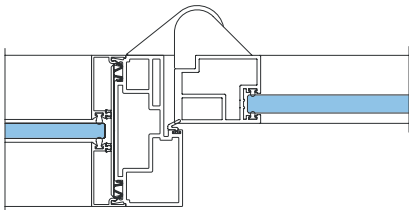

Wall Door Start Single Centered Glass (MFWWDSSC)

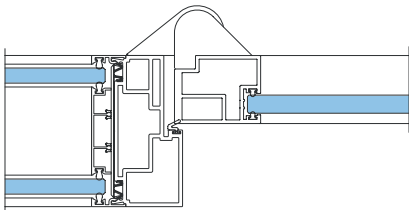

Wall Door Start Double Glass (MFWWDSG)

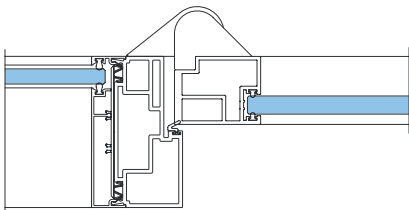

Wall Door Start Offset Glass (MFWWDSSO)

wall starts

wall starts

WALL START BASICS72

PLANNING WITH WALL STARTS73

wall start basics

Focus offers a variety of wall starts that allow glass fascias to connect to architectural walls.

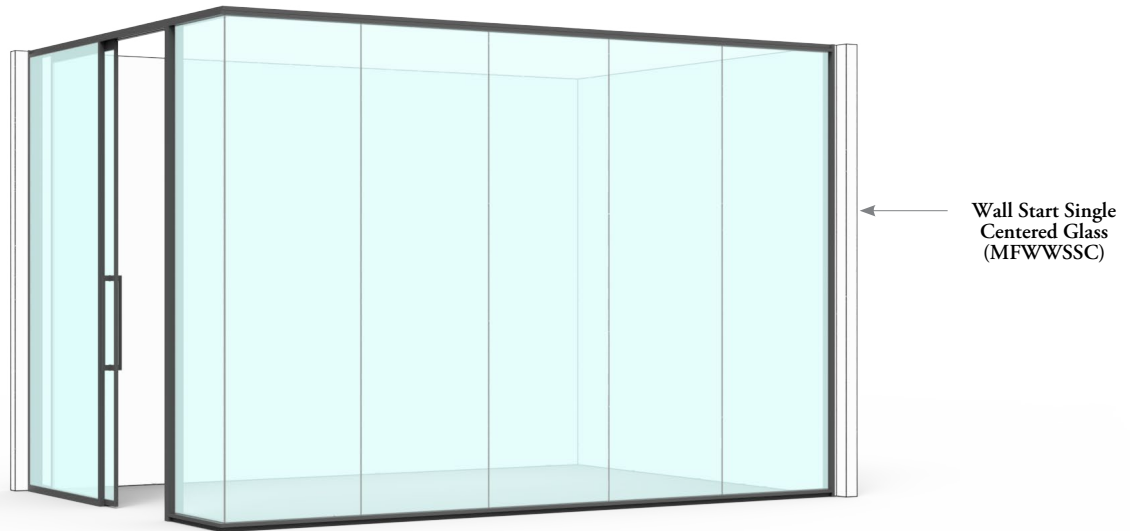

Frame finishes: Clear Anodized and Painted

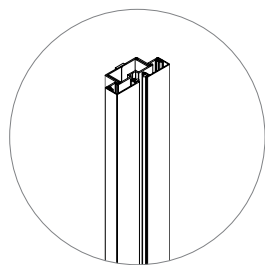

Wall Start Single Centered Glass (MFWSSC)
• Adjustable wall start for monolithic single centered glass fascias against drywall

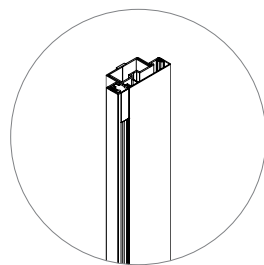

Wall Start Single Offset Glass (MFWSSO)
• Adjustable wall start for monolithic single offset glass fascias against drywall

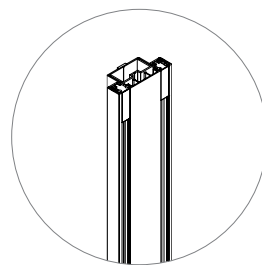

Wall Start Double Glass (MFWSDG)
• Adjustable wall start for monolithic double glass fascias against drywall

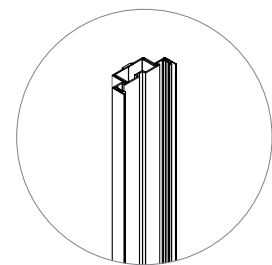

Wall Start Door (MFWSDD)
• Adjustable wall start for pivot/hinged/sliding doors against drywall

The following outlines the applications for each wall start type.

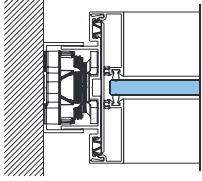

Wall Start Single Centered Glass (MFWSSC)

Can be used with center glass fascias against drywall

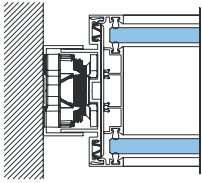

Wall Start Double Glass (MFWSDG)

Can be used with double glass fascias against drywall

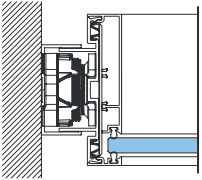

Wall Start Single Offset Glass (MFWSSO)

Can be used with offset glass fascias against drywall

The following outlines the applications for each wall start door.

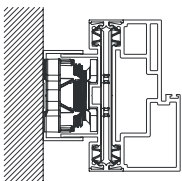

Wall Start Door (MFWSDDD)

Can be used with any door frame against drywall

wall transitions
& wall ends

wall transitions & wall ends

INLINE WALL TRANSITION BASICS	76
WALL TRANSITIONS CORNER BASICS	77
WALL END BASICS	78
PLANNING WITH WALL ENDS	79

inline wall transition basics

Focus offers a variety of vertical wall transitions for inline connections of glass, solid, filler panels and doors.

Inline Transition Connection –
Focus to Altos (MFWTCFA)
Single Center Glass option
shown

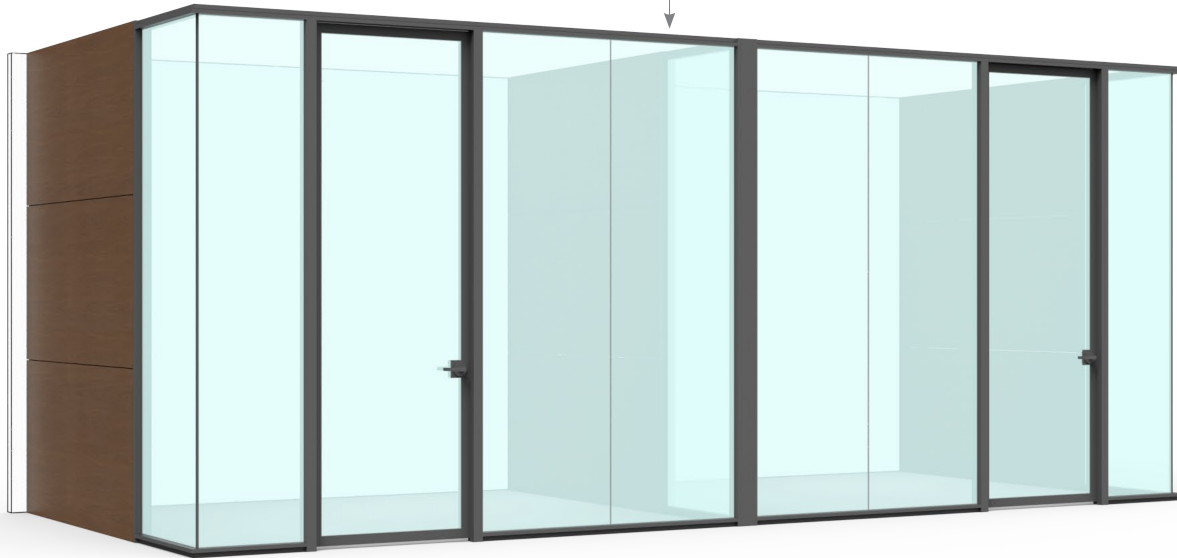

Frame finishes: Clear Anodized and Painted

The following describes inline transitions from Focus to Altos:

- Primarily used in demising wall applications
- Ideal when furniture integration is required
- Only used in inline applications
- Focus side of transition must be monolithic glass (single centered, offset or double glazed)
- Altos side of transition can be planned with monolithic solid (portrait/landscape), clerestory or any door type if required

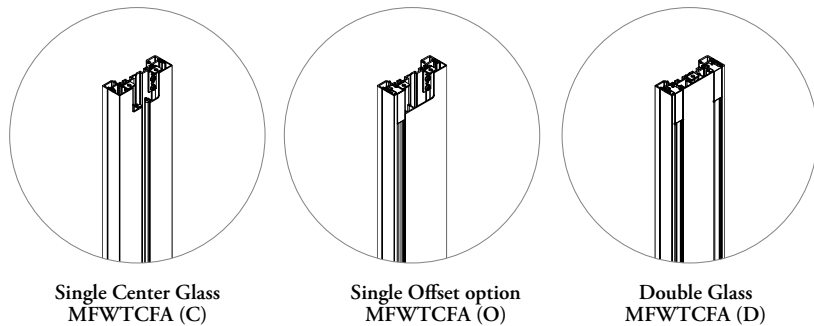

Single Center Glass
MFWTCFA (C)

Single Offset option
MFWTCFA (O)

Double Glass
MFWTCFA (D)

Inline Transition Connection – Focus to Altos (MFWTCFA)

Creates a vertical transition break between an inline Focus monolithic single centered, single offset and double glass partition to Altos

wall transitions corner basics

Focus offers a variety of corner transitions that can be used with or without wall ends to create a two-way, three-way and four-way connections.

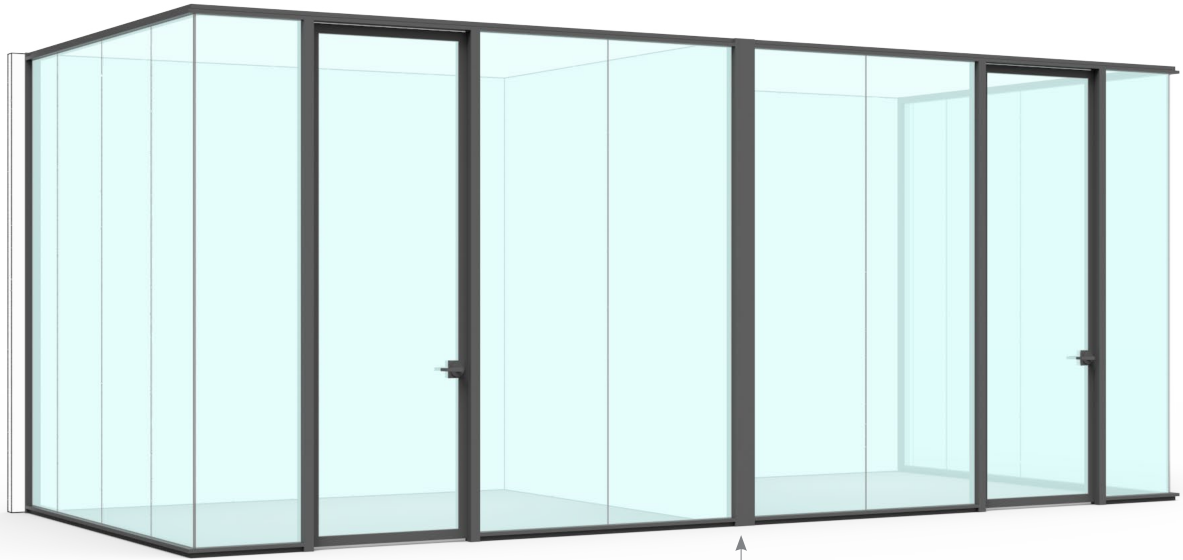

Frame finishes: Clear Anodized and Painted

Corner Transition (MFWTCD)

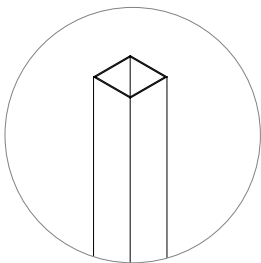

Corner Transition (MFWTCD)

Can be combined with wall end runs to create unique inline, corner, three-way and four-way transitions

wall end basics

Focus offers a variety of wall ends that connect to glass and solid fascias and doors.

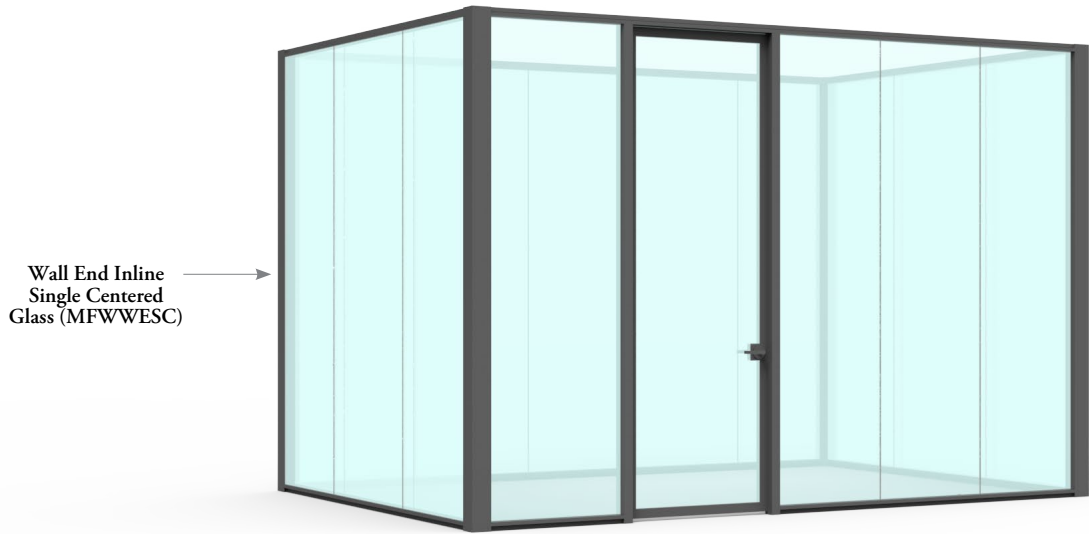

Wall End Inline Single Centered Glass (MFWWESC)

Frame finishes: Clear Anodized and Painted

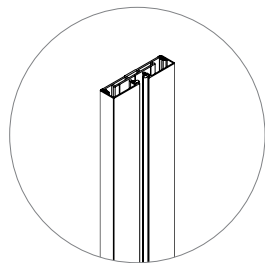

Wall End Inline Single Centered Glass (MFWWESC)

- Wall end inline for monolithic single centered glass

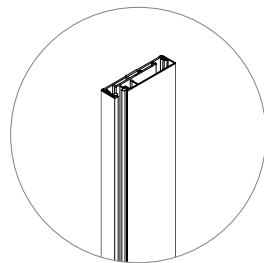

Wall End Inline Offset Glass (MFWWESO)

- Wall end inline for monolithic offset glass

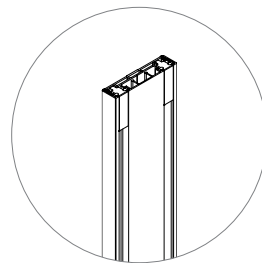

Wall End Inline Double Glass (MFWWEDG)

- Wall end inline for monolithic double glass

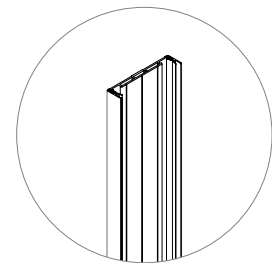

Wall End Inline Door (MFWWED)

- Wall end inline for pivot/hinged/sliding/doors

planning with wall ends

The following should be considered when planning with wall ends.

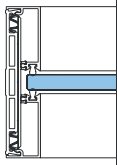

Wall End Inline Single Centered Glass (MFWWESC)

Can be used with center glass fascias at wall ends

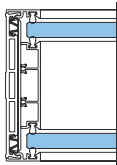

Wall End Inline Double Glass (MFWWEDG)

Can be used with double glass fascias at wall ends

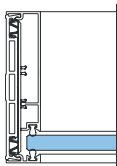

Wall End Inline Offset Glass (MFWWESO)

Can be used with offset glass fascias at wall ends

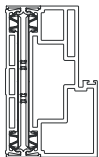

Wall End Inline Door (MFWWED)

- Can be used with any pivot, hinge or sliding door frame
- Corner transition (MFWTCD) must be specified in this application

planning with wall ends (continued)

Focus wall ends can be used together with corner transitions to create typical and non-typical planning solutions with glass and drywall fascias.

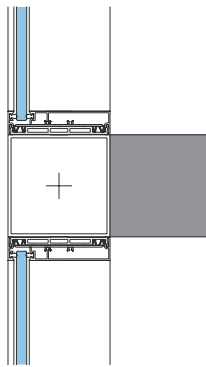

Three-way corner

- One Corner Transition (MFWTCD)
- Two Wall End Inline Offset Glass (MFWWESO)
- No wall end is required in this location, the corner transition mounts directly to the drywall

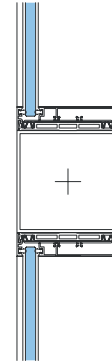
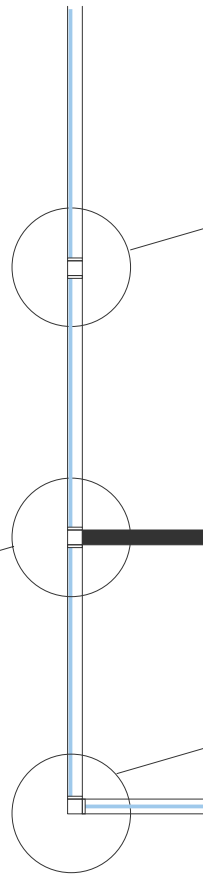

Inline

- One Corner Transition (MFWTCD)
- Two Wall End Inline Offset Glass (MFWWESO)

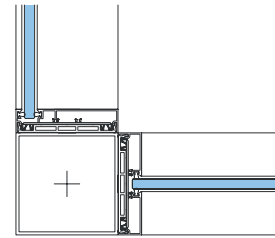

Two-way corner

- One Corner Transition (MFWTCD)
- One Wall End Inline Offset Glass (MFWWESO)
- One Wall End Inline Centered Glass (MFWWESC)

planning with wall ends (continued)

construction

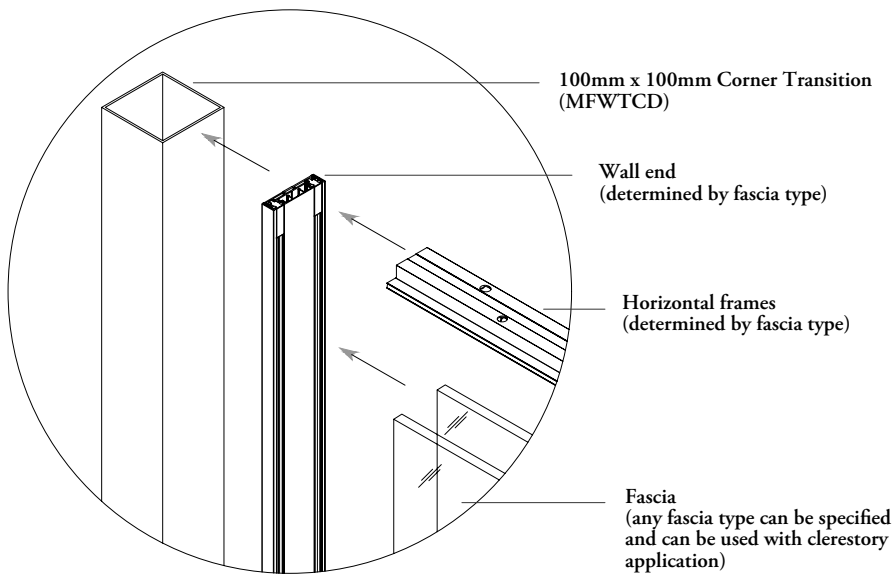

accessories

accessories

ACCESSORIES BASICS84

PLANNING WITH DOOR STOPS85

Focus offers a variety of accessories for walls and doors.

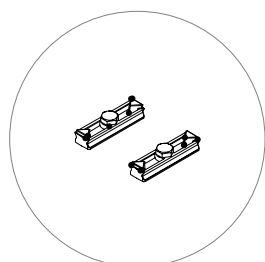
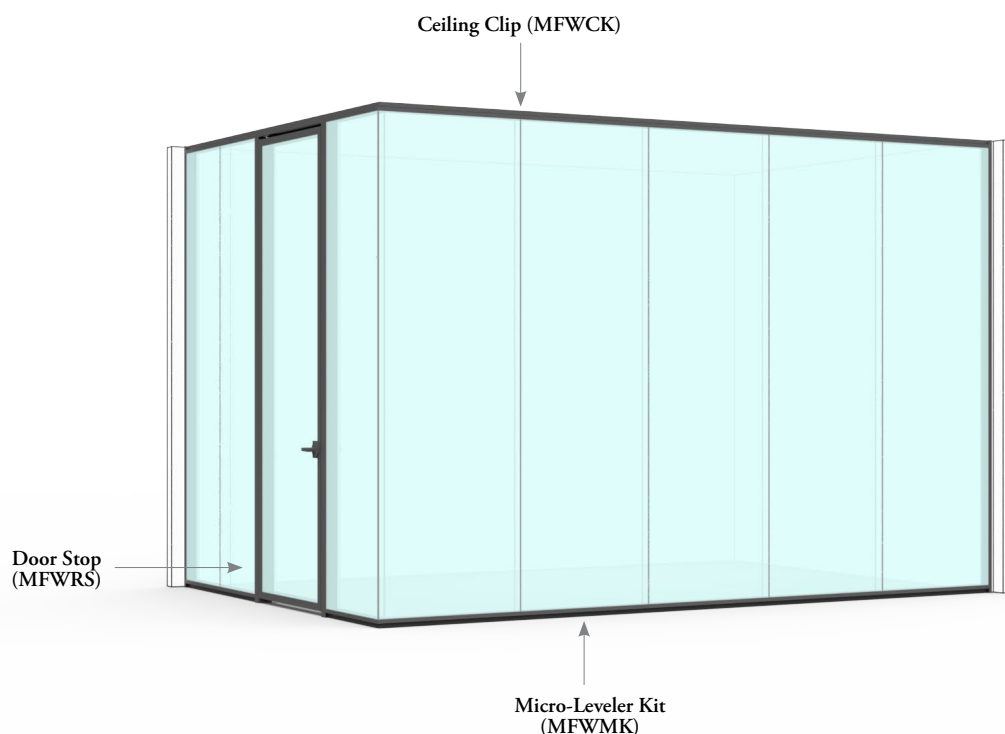

Micro-Leveler Kit (MFWMK)

- Adjustable plastic shims allow for micro-leveling under glass fascias during installation

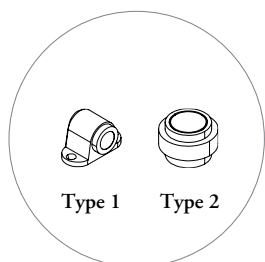

Door Stop (MFWRS)

- Available in two door stop types circular and magnetic

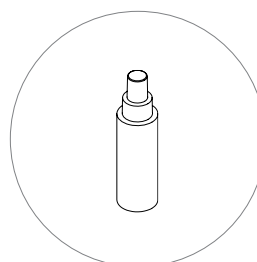

Activator Kit (MFWAK)

- Used to promote adhesion of Glazing Tapes to Glass surfaces.

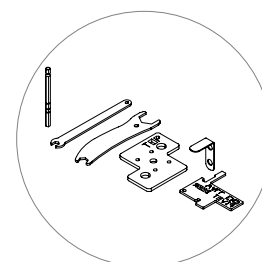

Installation Tool Kit (MFWTK)

- Available as a Full or Partial Installation Tool Kit

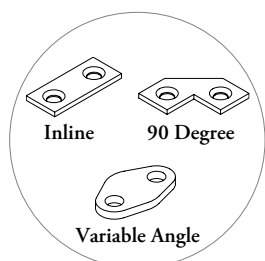

Splice Kit (MFWASK)

- Connects two straight end frame sections together

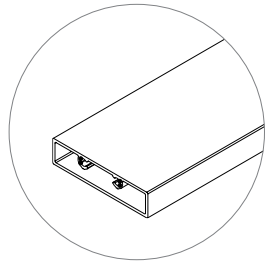

Ceiling Clip (MFWCK)

- Mounts above a ceiling to allow for the mounting of ceiling frames
- Only available in 5' length

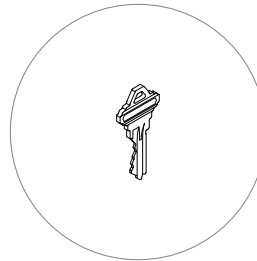

Control Key (MFWKK)

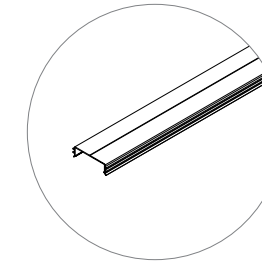

- Used to remove or install an interchangeable core



Frame Cut Fixture (MFWFX)

- Fixture for cutting base frame and ceiling frame components in one operation
- Can be used with ceiling frame, wall starts and door starts if required

The following outlines the features of Focus door stops.

		
Description	Magnetic door stop	Circular door stop
Teknion code	Door Stop, Type 1 (MFWRS1)	Door Stop, Type 2 (MFWRS2)
Finish	Stainless Steel (Grey Powder Coated Shims)	Stainless Steel (Black bumper)
Swing door compatibility	Framed pivot doors and Solid hinged door	All pivot / hinged door types
Other features	Shim kit for leveling included Magnetic feature holds door open	

When planning with the door stop:

1. Whenever possible, place the stop close to nearby walls so it is not an obstacle to the path of travel
2. Ensure the stop prevents door hardware (example: pulls, levers) from making contact with nearby walls
3. Position the stop so it is close to the outer edge of the door leaf for maximum support in the open position. The door stop needs to be installed at 4" from handle side

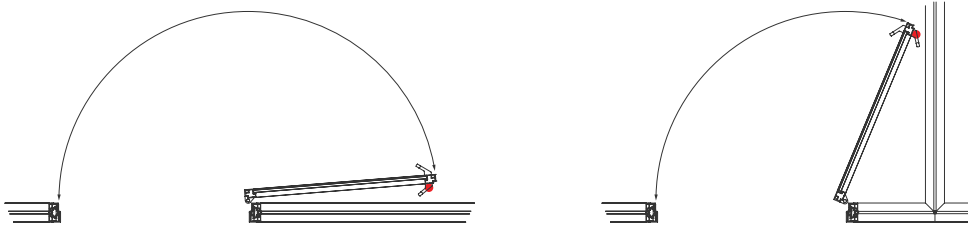

teknion

www.teknion.com

CAN/US/INT 11-24
©Teknion 2025

®, ™ trade marks of Teknion Corporation
and/or its subsidiaries or licensed to it.
Patents may be pending.

Some products may not be available in
all markets. Contact your local Teknion
Representative for availability.

NOV25-AIH-PG