

social
colla
bora
tive

seating

070	4	Shark	90
Beso	12	Hotel	95
F500	16	Nami	102
Gap	24	Arca	107
Kalm	30	Hive	114
Mare	34	Millepiedi	120
Nina	80	Not	132
Pala	86	Oracle	142

070 by artifort

features

Simply slim, clean lines, an elegant base and the single row of buttons as a finishing touch. There is such a thing as timeless design. With its pleasant, slightly raised and not too deep seat, the 070 provides a graceful contrast to all the excessive, soft and low lounge sofas of today.

Recently Artifort added new options to the iconic 070 series by Kho Liang Ie, tailored for the business and residential markets. In addition to the straight sofa with a padded backrest original compositions dating back to 1962 have returned to the collection, including a straight sofa with tabletop, a daybed with optional tabletop and the option of combining these into various configurations.

This gives architects the freedom they need to create inspirational waiting, meeting and lounging areas. The sofa's active seating comfort means that it is even suitable for concentrated work. All you need do is move a worktable up to the sofa in offices, public spaces and at home.

EARF070 070 chair

Product Options

Arm Style	Deep Padded Buttons	Gliders
Y with arms	Y Yes	F Felt Gliders
N without arms	N No	G Gliders, No Felt
L with arm left when seated		
R with arm right when seated		

Base Finishes	Upholstery Finishes
C6 Chrome	Fabrics

Notes 10cm width armrest
Larger leather sofas will have an extra stitching
If Gliders, Felt (Y) is specified, add 94

Price



EARF070Y

COM	COL	Gr.1	Gr.2	Gr.3	Gr.4	Gr.5	Gr.6	Gr.7	Gr.8	Gr.9	Gr.10
6214	6318	6412	6484	6557	6630	6703	6775	6848	6921	6994	7066



EARF070N

COM	COL	Gr.1	Gr.2	Gr.3	Gr.4	Gr.5	Gr.6	Gr.7	Gr.8	Gr.9	Gr.10
4800	4904	4904	4935	4966	4998	5029	5060	5091	5122	5153	5185



EARF070L

COM	COL	Gr.1	Gr.2	Gr.3	Gr.4	Gr.5	Gr.6	Gr.7	Gr.8	Gr.9	Gr.10
5507	5611	5663	5715	5766	5818	5870	5922	5974	6026	6078	6130



EARF070R

COM	COL	Gr.1	Gr.2	Gr.3	Gr.4	Gr.5	Gr.6	Gr.7	Gr.8	Gr.9	Gr.10
5507	5611	5663	5715	5766	5818	5870	5922	5974	6026	6078	6130

EARC070D 070 2 * sofa 2 seater

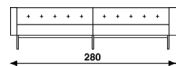
Product Options

Arm Style	Deep Padded Buttons	Gliders
1 with arms	Y Yes	F Felt Gliders
2 without arms	N No	G Gliders, No Felt
3 with arm left when seated		
4 with arm right when seated		

Base Finishes	Upholstery Finishes
C6 Chrome	Fabrics

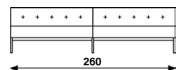
Notes 10cm width armrest
Larger leather sofas will have an extra stitching
If Gliders, Felt (Y) is specified, add 94

Price



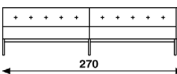
EARC070D1

COM	COL	Gr.1	Gr.2	Gr.3	Gr.4	Gr.5	Gr.6	Gr.7	Gr.8	Gr.9	Gr.10
19480	19688	20020	20228	20436	20644	20852	21059	21267	21475	21683	21891



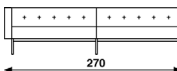
EARC070D2

COM	COL	Gr.1	Gr.2	Gr.3	Gr.4	Gr.5	Gr.6	Gr.7	Gr.8	Gr.9	Gr.10
18064	18272	18417	18584	18750	18916	19082	19249	19415	19581	19747	19913



EARC070D3

COM	COL	Gr.1	Gr.2	Gr.3	Gr.4	Gr.5	Gr.6	Gr.7	Gr.8	Gr.9	Gr.10
18773	18980	19230	19417	19604	19791	19978	20165	20352	20539	20726	20913



EARC070D4

COM	COL	Gr.1	Gr.2	Gr.3	Gr.4	Gr.5	Gr.6	Gr.7	Gr.8	Gr.9	Gr.10
18773	18980	19230	19417	19604	19791	19978	20165	20352	20539	20726	20913

EARC070T 070 sofa 2 and 2.5 seater with table

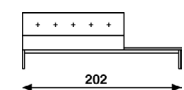
Product Options

Style	Arm Style	Table Position	Gliders	Deep Padded Buttons
1 Sofa 2 Seater	1 With Arms	R Table right when seated	Y With Felt	Y With
2 Sofa 2.5 Seater	2 Without Arms	L Table left when seated	N Without Felt	N Without

Netbox Finishes	Base Finishes	Upholstery Finishes	Table Finishes
1 1 Outlet	H Chrome	Fabrics	Solid Oak Wood
2 1 HDMI and USB data coupler			
3 2 RJ45 Coupler			
4 2 USB charger inc GST18			

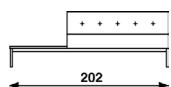
Notes 10cm width armrest
Larger leather sofas will have an extra stitching
If Gliders, Felt (Y) is specified, add 94

Price



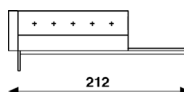
EARC070T11L

COM	COL	Gr.1	Gr.2	Gr.3	Gr.4	Gr.5	Gr.6	Gr.7	Gr.8	Gr.9	Gr.10
12140	12347	12374	12468	12562	12655	12749	12842	12936	13029	13123	13216



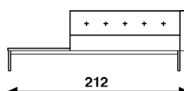
EARC070T11R

COM	COL	Gr.1	Gr.2	Gr.3	Gr.4	Gr.5	Gr.6	Gr.7	Gr.8	Gr.9	Gr.10
12140	12347	12374	12468	12562	12655	12749	12842	12936	13029	13123	13216



EARC070T12L

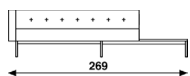
COM	COL	Gr.1	Gr.2	Gr.3	Gr.4	Gr.5	Gr.6	Gr.7	Gr.8	Gr.9	Gr.10
11370	11578	11557	11650	11744	11837	11931	12024	12118	12211	12305	12398



EARC070T12R

COM	COL	Gr.1	Gr.2	Gr.3	Gr.4	Gr.5	Gr.6	Gr.7	Gr.8	Gr.9	Gr.10
11370	11578	11557	11650	11744	11837	11931	12024	12118	12211	12305	12398

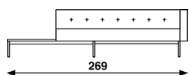
EARC070T 070 sofa 2 and 2.5 seater with table (continue)



EARC070T21L

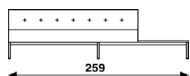
Price

COM	COL	Gr.1	Gr.2	Gr.3	Gr.4	Gr.5	Gr.6	Gr.7	Gr.8	Gr.9	Gr.10
13779	13987	14049	14143	14236	14330	14423	14517	14610	14704	14797	14891



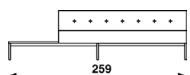
EARC070T21R

COM	COL	Gr.1	Gr.2	Gr.3	Gr.4	Gr.5	Gr.6	Gr.7	Gr.8	Gr.9	Gr.10
13779	13987	14049	14143	14236	14330	14423	14517	14610	14704	14797	14891



EARC070T22L

COM	COL	Gr.1	Gr.2	Gr.3	Gr.4	Gr.5	Gr.6	Gr.7	Gr.8	Gr.9	Gr.10
13072	13279	13296	13390	13483	13577	13670	13764	13857	13951	14044	14138



EARC070T22R

COM	COL	Gr.1	Gr.2	Gr.3	Gr.4	Gr.5	Gr.6	Gr.7	Gr.8	Gr.9	Gr.10
13072	13279	13296	13390	13483	13577	13670	13764	13857	13951	14044	14138

EARC070S 070 sofa 2 and 2.5 seater

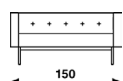
Product Options

Style	Arm Style	Deep Padded Buttons
1 Sofa 2 Seater	1 With Arms	Y With
2 Sofa 2.5 Seater	2 Without Arms	N Without
	3 With Arm left when seated	
	4 With Arm right when seated	

Gliders	Base Finishes	Upholstery Finishes
F Felt Gliders	C9 Chrome	Fabrics
G Gliders, No Felt		

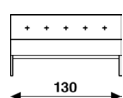
Notes 10cm width armrest
Larger leather sofas will have an extra stitching
If Gliders, Felt (Y) is specified, add 94

Price



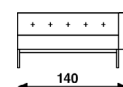
EARC070S11

COM	COL	Gr.1	Gr.2	Gr.3	Gr.4	Gr.5	Gr.6	Gr.7	Gr.8	Gr.9	Gr.10
10973	11077	11243	11347	11451	11555	11659	11763	11866	11970	12074	12178



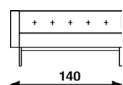
EARC070S12

COM	COL	Gr.1	Gr.2	Gr.3	Gr.4	Gr.5	Gr.6	Gr.7	Gr.8	Gr.9	Gr.10
9620	9724	9797	9880	9963	10046	10129	10212	10295	10379	10462	10545



EARC070S13

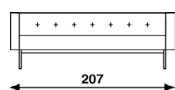
COM	COL	Gr.1	Gr.2	Gr.3	Gr.4	Gr.5	Gr.6	Gr.7	Gr.8	Gr.9	Gr.10
10390	10494	10619	10712	10806	10899	10993	11086	11180	11273	11367	11460



EARC070S14

COM	COL	Gr.1	Gr.2	Gr.3	Gr.4	Gr.5	Gr.6	Gr.7	Gr.8	Gr.9	Gr.10
10390	10494	10619	10712	10806	10899	10993	11086	11180	11273	11367	11460

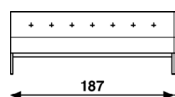
EARC070S 070 sofa 2 and 2.5 seater (continue)



EARC070S21

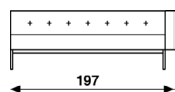
Price

COM	COL	Gr.1	Gr.2	Gr.3	Gr.4	Gr.5	Gr.6	Gr.7	Gr.8	Gr.9	Gr.10
12607	12711	12919	13075	13231	13386	13542	13698	13854	14010	14166	14322



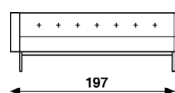
EARC070S22

COM	COL	Gr.1	Gr.2	Gr.3	Gr.4	Gr.5	Gr.6	Gr.7	Gr.8	Gr.9	Gr.10
11318	11422	11546	11640	11733	11827	11920	12014	12107	12201	12294	12388



EARC070S23

COM	COL	Gr.1	Gr.2	Gr.3	Gr.4	Gr.5	Gr.6	Gr.7	Gr.8	Gr.9	Gr.10
12024	12128	12315	12440	12565	12689	12814	12939	13063	13188	13313	13437



EARC070S24

COM	COL	Gr.1	Gr.2	Gr.3	Gr.4	Gr.5	Gr.6	Gr.7	Gr.8	Gr.9	Gr.10
12024	12128	12315	12440	12565	12689	12814	12939	13063	13188	13313	13437

EAR070T 070 daybed 2 and 2.5 seater

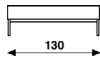
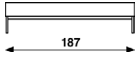
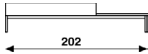
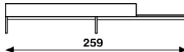
Product Options

Style	Deep Padded Buttons	Gliders	Netbox Style
1 Daybed 2 Seater 130 × 73cm	Y With	F Felt Gliders	0 No Netbox Style
2 Daybed 2.5 Seater 187 × 73cm	N Without	G Gliders, No Felt	1 1 Outlet
3 Daybed 2 Seater with Table			2 1 HDMI and USB Data Coupler
4 Daybed 2.5 Seater with Table			3 2 RJ45 Coupler
			4 2 USB Charger Inc GST18

Base Finishes	Upholstery Finishes	Table Finishes
C6 Chrome	Fabrics	Solid Oak Wood

Notes 10cm width armrest
 Larger leather sofas will have an extra stitching
 Table Finishes is applicable if style (3) & (4) option are selected
 If Gliders, Felt (Y) is specified, add 94
 If Netbox Style, (2) & (3) is specified add 284
 If Netbox Style, (1) is specified add 312
 If Netbox Style, (4) is specified add 899

Price

	EARC070T1	COM 7152	COL 7256	Gr.1 7308	Gr.2 7360	Gr.3 7412	Gr.4 7464	Gr.5 7516	Gr.6 7568	Gr.7 7620	Gr.8 7672	Gr.9 7724	Gr.10 7776
	EAR070T2	COM 8723	COL 8827	Gr.1 8879	Gr.2 8931	Gr.3 8983	Gr.4 9035	Gr.5 9087	Gr.6 9139	Gr.7 9191	Gr.8 9243	Gr.9 9295	Gr.10 9347
	EAR070T3	COM 8815	COL 8919	Gr.1 8971	Gr.2 9023	Gr.3 9075	Gr.4 9127	Gr.5 9179	Gr.6 9230	Gr.7 9282	Gr.8 9334	Gr.9 9386	Gr.10 9438
	EAR070T4	COM 10388	COL 10492	Gr.1 10544	Gr.2 10596	Gr.3 10648	Gr.4 10700	Gr.5 10752	Gr.6 10804	Gr.7 10855	Gr.8 10907	Gr.9 10959	Gr.10 11011

beso by artifort

features

Beso, Spanish for 'kiss', is a highly versatile and stylish chair program created by designer Khodi Feiz. The notion of lightness, flexibility and comfort is what striking in this design. The Beso collection includes a Beso chair, a Beso Lounge armchair, a Beso barstool and Beso Table.

We particularly like the juxtaposition between powerful and simplistic in the Beso design, so it works with most decors. In terms of shape and construction, the Beso chair allows for long comfortable dinners with friends and family or brainstorm sessions, without the need to take a break or stretch your legs. You can combine your favourite base with a beautiful fabric, and optional armrests.

EARB **beso chair**

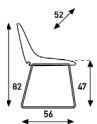
Product Options

Style		
A	Chair, Sled Base	K Armchair, 4-Star Wire Base
B	Chair, Wire Star Base	M Barstool, 4 Leg
C	Chair, 4 leg	N Barstool, Sled Base
E	Chair, 5-Star Sled Base	P Counter Stool, 4 Leg
F	Armchair, Sled Base	Q Counter Stool, Sled
G	Armchair, 4 leg	T Lounge Chair, 4-Star Swivel
J	Armchair, 5-Star Task	
		U Lounge Base, Wire Star Base
		V Lounge Base, Sled Base
		W Lounge Chair, Wood Leg

Seat Upholstery Finishes	Glides	Base Finish
Fabrics Leather	G Glides, No Felt F Felt Glides	C Chrome P Paint W Wood SS Stainless PA Polished Aluminum

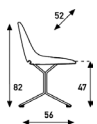
Notes Styles [B] & [K] are available only with Base Finish [P] Paint
 Styles [E] & [J] are available only with Base Finish [PA] Polished Aluminum
 Style [T] is available only with Base Finish [SS] Stainless
 Style [U] is available only with Base Finish [P] Paint
 Style [W] is available only with Base Finish [W] wood
 If Glides, [G] & [F] is specified add 83
 If Chrome, [C] is specified add 125

Price



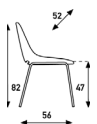
EARBA

COM	COL	Gr.1	Gr.2	Gr.3	Gr.4	Gr.5	Gr.6	Gr.7	Gr.8	Gr.9	Gr.10
2359	2410	2410	2442	2473	2504	2535	2566	2598	2629	2660	2691



EARBB

COM	COL	Gr.1	Gr.2	Gr.3	Gr.4	Gr.5	Gr.6	Gr.7	Gr.8	Gr.9	Gr.10
2466	2517	2517	2549	2580	2611	2642	2673	2705	2736	2767	2798



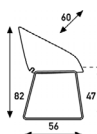
EARBC

COM	COL	Gr.1	Gr.2	Gr.3	Gr.4	Gr.5	Gr.6	Gr.7	Gr.8	Gr.9	Gr.10
2323	2376	2376	2407	2439	2470	2501	2532	2563	2594	2626	2657



EARBE

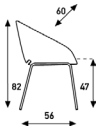
COM	COL	Gr.1	Gr.2	Gr.3	Gr.4	Gr.5	Gr.6	Gr.7	Gr.8	Gr.9	Gr.10
2751	2803	2803	2834	2866	2897	2928	2959	2990	3021	3053	3084



EARBF

COM	COL	Gr.1	Gr.2	Gr.3	Gr.4	Gr.5	Gr.6	Gr.7	Gr.8	Gr.9	Gr.10
2590	2642	2642	2673	2705	2736	2767	2798	2829	2860	2892	2923

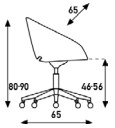
EARB **beso chair (continue)**



EARBG

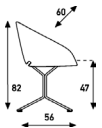
Price

COM	COL	Gr.1	Gr.2	Gr.3	Gr.4	Gr.5	Gr.6	Gr.7	Gr.8	Gr.9	Gr.10
2547	2599	2599	2630	2661	2692	2723	2754	2786	2817	2848	2879



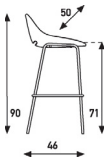
EARBJ

COM	COL	Gr.1	Gr.2	Gr.3	Gr.4	Gr.5	Gr.6	Gr.7	Gr.8	Gr.9	Gr.10
2972	3023	3023	3055	3086	3117	3148	3179	3211	3242	3273	3304



EARBK

COM	COL	Gr.1	Gr.2	Gr.3	Gr.4	Gr.5	Gr.6	Gr.7	Gr.8	Gr.9	Gr.10
2688	2740	2740	2771	2802	2833	2865	2896	2927	2958	2989	3020



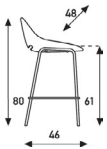
EARB M

COM	COL	Gr.1	Gr.2	Gr.3	Gr.4	Gr.5	Gr.6	Gr.7	Gr.8	Gr.9	Gr.10
2130	2182	2182	2213	2244	2275	2307	2338	2369	2400	2431	2462



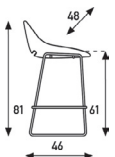
EARB N

COM	COL	Gr.1	Gr.2	Gr.3	Gr.4	Gr.5	Gr.6	Gr.7	Gr.8	Gr.9	Gr.10
2197	2249	2249	2281	2312	2343	2374	2405	2436	2468	2499	2530



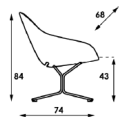
EARB P

COM	COL	Gr.1	Gr.2	Gr.3	Gr.4	Gr.5	Gr.6	Gr.7	Gr.8	Gr.9	Gr.10
2130	2182	2182	2213	2244	2275	2307	2338	2369	2400	2431	2462



EARB Q

COM	COL	Gr.1	Gr.2	Gr.3	Gr.4	Gr.5	Gr.6	Gr.7	Gr.8	Gr.9	Gr.10
2197	2249	2249	2281	2312	2343	2374	2405	2436	2468	2499	2530



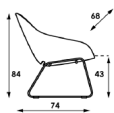
EARB T

COM	COL	Gr.1	Gr.2	Gr.3	Gr.4	Gr.5	Gr.6	Gr.7	Gr.8	Gr.9	Gr.10
5409	5513	5513	5544	5575	5606	5638	5669	5700	5731	5762	5793

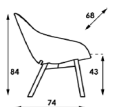
EARB **beso chair (continue)**

Price

EARBU	COM	COL	Gr.1	Gr.2	Gr.3	Gr.4	Gr.5	Gr.6	Gr.7	Gr.8	Gr.9	Gr.10
	4643	4747	4747	4778	4810	4841	4872	4903	4934	4965	4997	5028



EARBV	COM	COL	Gr.1	Gr.2	Gr.3	Gr.4	Gr.5	Gr.6	Gr.7	Gr.8	Gr.9	Gr.10
	4407	4511	4511	4543	4574	4605	4636	4667	4698	4730	4761	4792



EARBW	COM	COL	Gr.1	Gr.2	Gr.3	Gr.4	Gr.5	Gr.6	Gr.7	Gr.8	Gr.9	Gr.10
	5798	5902	5902	5933	5964	5995	6026	6057	6089	6120	6151	6182

F500 by artifort

features

Designer Geoffrey D. Harcourt RDI distinguished himself with this series swivel chairs by the comfort form and striking upholstery. The idea of the F500 armchair originate because the girlfriend of Harcourt RDI like to curl up in cross-leggs. He was fascinated by this very female attitude. The result is the F500 series: an armchair with all comfort of an easy chair, and wide enough to suit an unusual seating position.

These comfortable F 500 shells on a metal base are pleasantly futuristic but, at the same time, nostalgic.

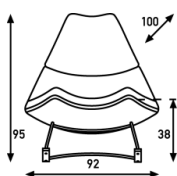
With its extra thick upholstery, the F510 and F512 is an armchair to curl up in and enjoy. Available in a high and a low version. The swivel armchair is available with a disc base, cross base or with a rocking base.

EARF510 500 series rocking chair thick, fixed upholstery
EARF511 500 series lounge chair low swiveling

Product Options

Upholstery Finishes	Paint Finishes
Fabrics Leather	Paint Powder

Notes Steel base in standard powder coating colours for EARF510
 Wooden parts available in standard oil finish for EARF510
 Disc is delivered standard with plastic ring at the underside for EARF511

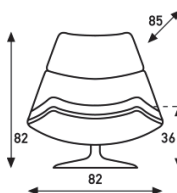


EARF510

Price

COM	COL	Gr.1	Gr.2	Gr.3	Gr.4	Gr.5	Gr.6	Gr.7	Gr.8	Gr.9	Gr.10
10580	10788	10778	10840	10902	10965	11027	11089	11152	11214	11276	11339

Leather
LC
12024



EARF511

COM	COL	Gr.1	Gr.2	Gr.3	Gr.4	Gr.5	Gr.6	Gr.7	Gr.8	Gr.9	Gr.10
10673	10372	10362	10424	10487	10549	10611	10674	10736	10798	10861	10923

Leather
LC
11609

EARF584 500 series lounge chair, disc base, fixed upholstery with welt low swiveling

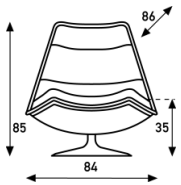
EARF585 500 series lounge chair high swiveling

Product Options

Upholstery Finishes

Fabrics
Leather

Notes Disc is delivered standard with plastic ring at the underside

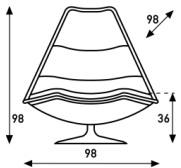


EARF584

Price

COM	COL	Gr.1	Gr.2	Gr.3	Gr.4	Gr.5	Gr.6	Gr.7	Gr.8	Gr.9	Gr.10
9214	9422	9422	9484	9546	9609	9671	9733	9796	9858	9920	9983

Leather
LC
10668



EARF585

COM	COL	Gr.1	Gr.2	Gr.3	Gr.4	Gr.5	Gr.6	Gr.7	Gr.8	Gr.9	Gr.10
9609	9816	9806	9868	9931	9993	10055	10118	10180	10242	10305	10367

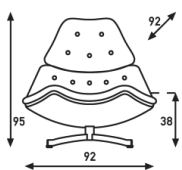
Leather
LC
11053

EARF587 500 series lounge chair high swiveling
EARF587L 500 series lounge chair low swiveling

Product Options

Upholstery Finishes	Paint Finishes
Fabrics Leather	Paint Powder Stainless Steel

Notes Finish base polished stainless steel or coating colour
 Upholstery : 3 loose cushions with buttons
 EARF587 : 35 buttons
 EARF587L : 26 buttons

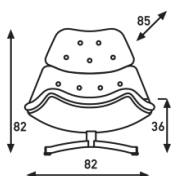


EARF587

Price

COM	COL	Gr.1	Gr.2	Gr.3	Gr.4	Gr.5	Gr.6	Gr.7	Gr.8	Gr.9	Gr.10
11437	11645	11645	11707	11770	11832	11894	11957	12019	12081	12144	12206

Leather
LC
 12892



EARF587L

COM	COL	Gr.1	Gr.2	Gr.3	Gr.4	Gr.5	Gr.6	Gr.7	Gr.8	Gr.9	Gr.10
10501	10709	10709	10771	10834	10896	10958	11021	11083	11145	11208	11270

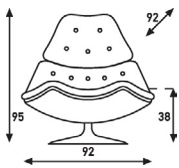
Leather
LC
 11956

EARF588 500 series lounge chair, disc base high swiveling
EARF588L 500 series lounge chair, disc base, tufted upholstery low swiveling

Product Options

Upholstery Finishes	Paint Finishes
Fabrics Leather	Paint Powder

Notes Disc is delivered standard with plastic ring at the underside
 Upholstery : 3 loose cushions with buttons
 EARF588 : 35 buttons

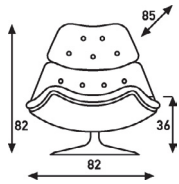


EARF588

Price

COM	COL	Gr.1	Gr.2	Gr.3	Gr.4	Gr.5	Gr.6	Gr.7	Gr.8	Gr.9	Gr.10
11187	11395	11384	11447	11509	11571	11634	11696	11758	11821	11883	11945

Leather
LC
12631



EARF588L

COM	COL	Gr.1	Gr.2	Gr.3	Gr.4	Gr.5	Gr.6	Gr.7	Gr.8	Gr.9	Gr.10
10251	10459	10459	10521	10583	10646	10708	10770	10833	10895	10957	11020

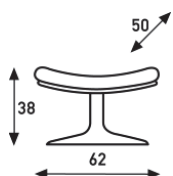
Leather
LC
11705

EARP510 500 series lounge chair, disc base, footstool non swiveling
EARP588 500 series disc base, tufted upholstery footstool non swiveling

Product Options

Upholstery Finishes	Paint Finishes
Fabrics Leather	Paint Powder

Notes Disc is delivered standard with plastic ring at the underside
 Upholstery : 3 loose cushions with buttons
 Only MARP588 : 10 buttons

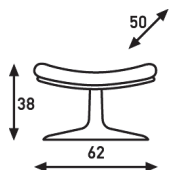


EARP510

Price

COM	COL	Gr.1	Gr.2	Gr.3	Gr.4	Gr.5	Gr.6	Gr.7	Gr.8	Gr.9	Gr.10
3652	3704	3704	3735	3766	3798	3829	3860	3891	3922	3953	3985

Leather
LC
4327



EARP588

COM	COL	Gr.1	Gr.2	Gr.3	Gr.4	Gr.5	Gr.6	Gr.7	Gr.8	Gr.9	Gr.10
4110	4162	4162	4193	4225	4256	4287	4318	4349	4380	4412	4443

Leather
LC
4786

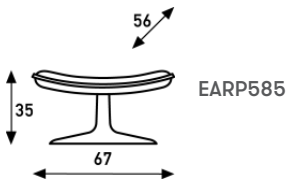
EARP585 500 series disc base, fixed upholstery with welt footstool non swiveling

Product Options

Upholstery Finishes

Fabrics
Leather

Notes Disc is delivered standard with plastic ring at the underside



Price

COM	COL	Gr.1	Gr.2	Gr.3	Gr.4	Gr.5	Gr.6	Gr.7	Gr.8	Gr.9	Gr.10
3715	3767	3767	3799	3830	3861	3892	3923	3954	3986	4017	4048

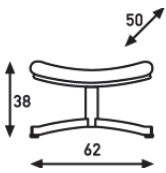
Leather
LC
4391

EARP587 500 series tufted upholstery, footstool non swiveling

Product Options

Upholstery Finishes	Paint Finishes
Fabrics Leather	Paint Powder Stainless Steel

Notes Finish base polished stainless steel or coating colour
 Upholstery : 3 loose cushions with buttons
 Only MARP587 : 10 buttons



EARP587

Price

COM	COL	Gr.1	Gr.2	Gr.3	Gr.4	Gr.5	Gr.6	Gr.7	Gr.8	Gr.9	Gr.10
4362	4414	4414	4445	4476	4507	4538	4570	4601	4632	4663	4694

Leather
 LC
 5037

gap by artifort

features

Meeting and dining chair Gap is a design by Khodi Feiz. The distinctive gap in the fully upholstered shell appears where the seat ends and the back begins. It's this smile-shaped gap that gives the design just that little bit extra, providing more room for the back and guaranteeing comfortable sitting.

Gap is available in various types of bases and can be upholstered in both fabric and leather. Gap adapts effortlessly in various settings such as conference rooms, meeting rooms and restaurants.

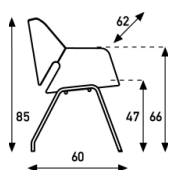
EARGAP1 gap 4 legged single upholstery
EARGAP_ gap 4 legged double upholstery

Product Options

Upholstery Style		Felt Gliders		Base Finishes	Seat Upholstery Finishes	Back Upholstery Finishes
S	Single Upholstery	Y	Yes	Powder Coated	Fabric	Fabric
D	Double upholstery	N	No	Chrome		

Notes Upholstery in two colours of one fabric is possible
 One colour for back and one colour for the seat
 If Double Upholstery is specified, add 83 for back upholstery
 If Felt Gliders (Y) is specified, add 42
 If Chrome is specified, add 125

Price



EARGAP1

EARGAP1_

COM	COL	Gr.1	Gr.2	Gr.3	Gr.4	Gr.5	Gr.6	Gr.7	Gr.8	Gr.9	Gr.10
3366	3418	3470	3501	3533	3564	3595	3626	3657	3688	3720	3751
COM	COL	Gr.1	Gr.2	Gr.3	Gr.4	Gr.5	Gr.6	Gr.7	Gr.8	Gr.9	Gr.10
3449	3501	3553	3585	3616	3647	3678	3709	3740	3772	3803	3834

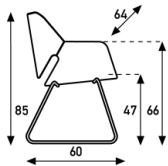
EARGAP2 gap sled single upholstery
EARGAP2_ gap sled double upholstery

Product Options

Upholstery Style	Felt Gliders	Base Finishes	Seat Upholstery Finishes	Back Upholstery Finishes
S Single Upholstery	Y Yes	Powder Coated	Fabric	Fabric
D Double upholstery	N No	Chrome		

Notes Upholstery in two colours of one fabric is possible
 One colour for back and one colour for the seat
 If Double Upholstery is specified, add 83 for back upholstery
 If Felt Gliders (Y) & (N) are specified, add 83
 If Chrome is specified, add 125

Price



EARGAP2

EARGAP2_

COM	COL	Gr.1	Gr.2	Gr.3	Gr.4	Gr.5	Gr.6	Gr.7	Gr.8	Gr.9	Gr.10
3366	3418	3470	3501	3533	3564	3595	3626	3657	3688	3720	3751

COM	COL	Gr.1	Gr.2	Gr.3	Gr.4	Gr.5	Gr.6	Gr.7	Gr.8	Gr.9	Gr.10
3449	3501	3553	3585	3616	3647	3678	3709	3740	3772	3803	3834

EARGAP3 gap 5 legged height adjustable single upholstery
EARGAP3_ gap 5 legged height adjustable double upholstery

Product Options

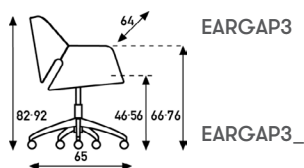
Upholstery Style	Castor Style	Base Finishes	Seat Upholstery Finishes	Back Upholstery Finishes
S Single Upholstery	Hard	Powder Coated	Fabric	Fabric
D Double upholstery	Soft	Polished Aluminum		

Notes If the base is polished aluminum, gas spring and castor caps always chrome
 Castors standard soft tread breaking
 Upholstery in two colours of one fabric is possible
 One colour for back and one colour for the seat
 If Double Upholstery is specified, add 83 for back upholstery
 If Chrome is specified, add 166

Price

COM	COL	Gr.1	Gr.2	Gr.3	Gr.4	Gr.5	Gr.6	Gr.7	Gr.8	Gr.9	Gr.10
3742	3794	3846	3878	3909	3940	3971	4002	4033	4065	4096	4127

COM	COL	Gr.1	Gr.2	Gr.3	Gr.4	Gr.5	Gr.6	Gr.7	Gr.8	Gr.9	Gr.10
3825	3877	3928	3960	3991	4022	4053	4084	4115	4147	4178	4209



jima by artifort

features

Form, function, comfort and detail: the Jima chair by designer Patrick Norguet ticks all the boxes. This sleek, expressive chair will fit seamlessly into different worlds – an office for instance, and a home for sure.

Jima comes in high back and low back versions, and is available in four different bases. The chair comes in an extensive range of fabrics and colours, inviting you to experiment with any interior style.

EARJ jima chair

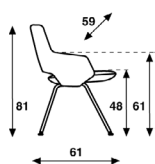
Product Options

Style	Back Height	Seat Upholstery Finishes	Glide	Back Finishes
A 4-Leg Base	L Low Back	Fabric Leather	C Casters	C9 Polished Aluminum
B 4-Star Swivel Base	H High Back		F Felt Glides	C6 Chrome
C 5-Star Task Base			G Glides No Felt	P Paint

Notes

- If style (A) or (B) is specified, then caster option (C) not available
- If style (C) is specified, then glide option (G) is not available
- If style (A) is specified, then base finish option (C9) is not available
- If style (B) is specified, then base finish option (C6) is not available
- If style (C) is specified, then base finish option (C) is not available
- Add 472 for EARJAH high back option
- Add 198 for EARJBH high back option
- Add 746 for EARJCH high back option

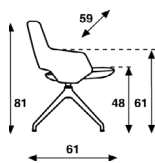
Price



EARJAL

COM	COL	Gr.1	Gr.2	Gr.3	Gr.4	Gr.5	Gr.6	Gr.7	Gr.8	Gr.9	Gr.10
2793	2897	2845	2897	2949	3001	3053	3105	3156	3208	3260	3312

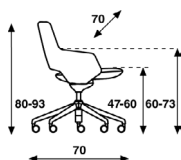
Leather
LC
3884



EARJBL

COM	COL	Gr.1	Gr.2	Gr.3	Gr.4	Gr.5	Gr.6	Gr.7	Gr.8	Gr.9	Gr.10
3233	3337	3285	3337	3389	3441	3493	3545	3597	3649	3701	3753

Leather
LC
4324



EARJCL

COM	COL	Gr.1	Gr.2	Gr.3	Gr.4	Gr.5	Gr.6	Gr.7	Gr.8	Gr.9	Gr.10
2959	3063	3011	3063	3115	3166	3218	3271	3323	3375	3427	3479

Leather
LC
4050

kalm by artifort

features

Kalm is Artifort's large, new cosy armchair by our French designer Patrick Norguet. It is a sanctuary in its own right, a place to unwind and get comfortable. With Kalm, Patrick Norguet has created an iconic, luxurious and comfortable high-back armchair for your living room or study.

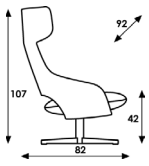
Kalm is not only a beautiful chair that will earn a special place for itself in your home. According to Norguet, it is also 'an expressive armchair that is suitable in any project environment. Several Kalm armchairs grouped together will definitely define a hotel lobby or meeting room and create a distinguished and iconic image.'

Kalm can be combined with a matching footstool, which has an upholstered cushion in the same shape as the cushion in the chair.

EARKA kalm lounge chair, 4-star swivel
EARKB kalm footstool, 4-star

Product Options

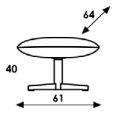
Seat Upholstery Finish	Base Finish
Fabric	S1 Stainless Steel



EARKA

Price

COM	COL	Gr.1	Gr.2	Gr.3	Gr.4	Gr.5	Gr.6	Gr.7	Gr.8	Gr.9	Gr.10
7268	7372	7476	7548	7621	7694	7767	7839	7912	7985	8057	8130



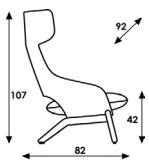
EARKB

COM	COL	Gr.1	Gr.2	Gr.3	Gr.4	Gr.5	Gr.6	Gr.7	Gr.8	Gr.9	Gr.10
3183	3287	3391	3464	3537	3609	3682	3755	3828	3900	3973	4046

EARKD kalm lounge chair, wood leg
EARKE kalm footstool, wood leg

Product Options

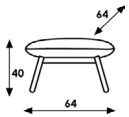
Seat Upholstery Finish	Wood Base Finish
Fabric	BU Basque White Oak NK Natural Oak DY Cocoa Brown DV Sierra DZ Truffle



EARKD

Price

COM	COL	Gr.1	Gr.2	Gr.3	Gr.4	Gr.5	Gr.6	Gr.7	Gr.8	Gr.9	Gr.10
7892	7996	8100	8173	8246	8318	8391	8464	8536	8609	8682	8755



EARKE

COM	COL	Gr.1	Gr.2	Gr.3	Gr.4	Gr.5	Gr.6	Gr.7	Gr.8	Gr.9	Gr.10
3751	3855	3959	4031	4104	4177	4250	4322	4395	4468	4540	4613

mare by artifort

features

With its clean lines and subtle details, the Mare fixed cushion programme is timeless. Typical of René Holten's design is the slit in the centre of the seat and the slender base, which runs from back to front. This gives the sofa a spacious and elegant appearance, particularly in a open space.

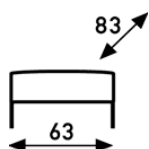
Thanks to its wide range of versatile elements, the Mare is a much loved sofa. Opt for a compact, straight sofa (2-, 2.2-, 2.5-, or 3-seater sofa) or a large lounge ensemble ideally suited to both modern and classic interiors. However, the underlying goal of each Mare remains the same: to provide the ultimate in comfort.

EARFC300 mare fix cushion footstool 63 × 83cm

Product Options

Seat Height	Armrest Size	Base Finishes	Seat and Back Upholstery Finish
43 43cm	12 12cm width	Powder Coated	Fabrics
45 45cm	21 21cm width	Polished Stainless Steel	Leather

Notes Caps with felt
 Depending on the chosen upholstery, after a while pleats will appear. This can not be avoided
 Mare fixed cushion can be ordered in different compositions
 If Polished Stainless Steel is specified add 634
 If Armrest Size, (21) is specified add 666



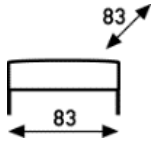
		Price											
EARFC300		COM	COL	Gr.1	Gr.2	Gr.3	Gr.4	Gr.5	Gr.6	Gr.7	Gr.8	Gr.9	Gr.10
		4392	4496	4475	4506	4537	4568	4600	4631	4662	4693	4724	4756
Leather													
LC													
5098													

EARFC301 mare fix cushion footstool 83 × 83cm

Product Options

Seat Height	Armrest Size	Base Finishes	Seat and Back Upholstery Finish
43 43cm	12 12cm width	Powder Coated	Fabrics
45 45cm	21 21cm width	Polished Stainless Steel	Leather

Notes Caps with felt
 Depending on the chosen upholstery, after a while pleats will appear. This can not be avoided
 Mare fixed cushion can be ordered in different compositions
 If Polished Stainless Steel is specified add 634
 If Armrest Size, (21) is specified add 666



EARFC301

Price

COM	COL	Gr.1	Gr.2	Gr.3	Gr.4	Gr.5	Gr.6	Gr.7	Gr.8	Gr.9	Gr.10
4392	4496	4475	4506	4537	4568	4600	4631	4662	4693	4724	4756

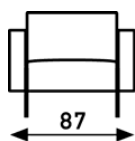
Leather
 LC
 5098

EARFC302 mare fix cushion armchair 87cm wide

Product Options

Seat Height	Armrest Size	Base Finishes	Seat and Back Upholstery Finish
43 43cm	12 12cm width	Powder Coated	Fabrics
45 45cm	21 21cm width	Polished Stainless Steel	Leather

Notes Caps with felt
 Depending on the chosen upholstery, after a while pleats will appear. This can not be avoided
 Mare fixed cushion can be ordered in different compositions
 If Polished Stainless Steel is specified add 634
 If Armrest Size, (21) is specified add 666



EARFC302

Price

COM	COL	Gr.1	Gr.2	Gr.3	Gr.4	Gr.5	Gr.6	Gr.7	Gr.8	Gr.9	Gr.10
6546	6650	6743	6795	6847	6899	6951	7003	7055	7107	7159	7211

Leather
 LC
 7782

EARFC303 mare fix cushion armchair 115cm wide

Product Options

Seat Height	Armrest Size	Base Finishes	Seat and Back Upholstery Finish
43 43cm	12 12cm width	Powder Coated	Fabrics
45 45cm	21 21cm width	Polished Stainless Steel	Leather

Notes Caps with felt
 Depending on the chosen upholstery, after a while pleats will appear. This can not be avoided
 Mare fixed cushion can be ordered in different compositions
 If Polished Stainless Steel is specified add 634
 If Armrest Size, (21) is specified add 666



EARFC303

Price

COM	COL	Gr.1	Gr.2	Gr.3	Gr.4	Gr.5	Gr.6	Gr.7	Gr.8	Gr.9	Gr.10
7226	7330	7424	7476	7528	7580	7631	7683	7735	7787	7839	7891

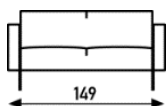
Leather
 LC
 8463

EARFC304 mare fix cushion sofa 2-seater

Product Options

Seat Height	Armrest Size	Base Finishes	Seat and Back Upholstery Finish
43 43cm	12 12cm width	Powder Coated	Fabrics
45 45cm	21 21cm width	Polished Stainless Steel	Leather

Notes Caps with felt
 Depending on the chosen upholstery, after a while pleats will appear. This can not be avoided
 Mare fixed cushion can be ordered in different compositions
 If Polished Stainless Steel is specified add 634
 If Armrest Size, (21) is specified add 666



EARFC304

Price

COM	COL	Gr.1	Gr.2	Gr.3	Gr.4	Gr.5	Gr.6	Gr.7	Gr.8	Gr.9	Gr.10
9999	10207	10244	10316	10389	10462	10534	10607	10680	10753	10825	10898

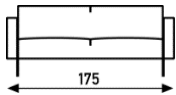
Leather
 LC
 11698

EARFC305 mare fix cushion sofa 2.2-seater

Product Options

Seat Height	Armrest Size	Base Finishes	Seat and Back Upholstery Finish
43 43cm	12 12cm width	Powder Coated	Fabrics
45 45cm	21 21cm width	Polished Stainless Steel	Leather

Notes Caps with felt
 Depending on the chosen upholstery, after a while pleats will appear. This can not be avoided
 Mare fixed cushion can be ordered in different compositions
 If Polished Stainless Steel is specified add 634
 If Armrest Size, (21) is specified add 666



EARFC305

Price

COM	COL	Gr.1	Gr.2	Gr.3	Gr.4	Gr.5	Gr.6	Gr.7	Gr.8	Gr.9	Gr.10
10525	10733	10816	10920	11024	11128	11232	11335	11439	11543	11647	11751

Leather
 LC
 12894

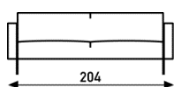
EARFC306 mare fix cushion sofa 2.5-seater

Product Options

Seat Height	Armrest Size	Base Finishes	Seat and Back Upholstery Finish
43 43cm	12 12cm width	Powder Coated	Fabrics
45 45cm	21 21cm width	Polished Stainless Steel	Leather

Notes Caps with felt
 Depending on the chosen upholstery, after a while pleats will appear. This can not be avoided
 Mare fixed cushion can be ordered in different compositions
 If Polished Stainless Steel is specified add 634
 If Armrest Size, (21) is specified add 666

Price



EARFC306

COM	COL	Gr.1	Gr.2	Gr.3	Gr.4	Gr.5	Gr.6	Gr.7	Gr.8	Gr.9	Gr.10
11191	11399	11509	11613	11717	11821	11925	12029	12132	12236	12340	12444

Leather
LC
 13587

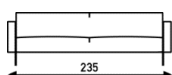
EARFC307 mare fix cushion sofa 3-seater

Product Options

Seat Height	Armrest Size	Base Finishes	Seat and Back Upholstery Finish
43 43cm	12 12cm width	Powder Coated	Fabrics
45 45cm	21 21cm width	Polished Stainless Steel	Leather

Notes Caps with felt
 Depending on the chosen upholstery, after a while pleats will appear. This can not be avoided
 Mare fixed cushion can be ordered in different compositions
 If Polished Stainless Steel is specified add 634
 If Armrest Size, (21) is specified add 665

Price



EARFC307

COM	COL	Gr.1	Gr.2	Gr.3	Gr.4	Gr.5	Gr.6	Gr.7	Gr.8	Gr.9	Gr.10
12369	12577	12760	12885	13009	13134	13259	13383	13508	13633	13757	13882

Leather
LC
 15254

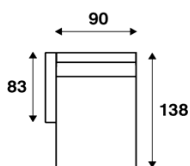
EARFC308 mare fix cushion chaise lounge right
EARFC309 mare fix cushion chaise lounge left

Product Options

Seat Height	Armrest Size	Base Finishes	Seat and Back Upholstery Finish
43 43cm	12 12cm width	Powder Coated	Fabrics
45 45cm	21 21cm width	Polished Stainless Steel	Leather

Notes Caps with felt
 Depending on the chosen upholstery, after a while pleats will appear. This can not be avoided
 Mare fixed cushion can be ordered in different compositions
 If Polished Stainless Steel is specified add 634
 If Armrest Size, [21] is specified add 335

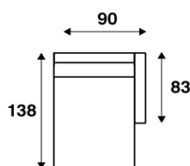
Price



EARFC308

COM	COL	Gr.1	Gr.2	Gr.3	Gr.4	Gr.5	Gr.6	Gr.7	Gr.8	Gr.9	Gr.10
9805	10013	10138	10241	10345	10449	10553	10657	10761	10865	10969	11073

Leather
 LC
 12216



EARFC309

COM	COL	Gr.1	Gr.2	Gr.3	Gr.4	Gr.5	Gr.6	Gr.7	Gr.8	Gr.9	Gr.10
9805	10013	10138	10241	10345	10449	10553	10657	10761	10865	10969	11073

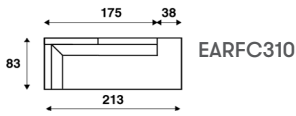
Leather
 LC
 12216

EARFC310 mare fix cushion dormeuse right
EARFC311 mare fix cushion dormeuse left

Product Options

Seat Height	Base Finishes	Seat and Back Upholstery Finish
43 43cm	Powder Coated	Fabrics
45 45cm	Polished Stainless Steel	Leather

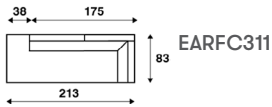
Notes Caps with felt
 Depending on the chosen upholstery, after a while pleats will appear. This can not be avoided
 Mare fixed cushion can be ordered in different compositions
 If Polished Stainless Steel is specified add 634



Price

COM	COL	Gr.1	Gr.2	Gr.3	Gr.4	Gr.5	Gr.6	Gr.7	Gr.8	Gr.9	Gr.10
11885	12093	12208	12312	12416	12520	12624	12728	12832	12936	13039	13143

Leather
 LC
 14286



COM	COL	Gr.1	Gr.2	Gr.3	Gr.4	Gr.5	Gr.6	Gr.7	Gr.8	Gr.9	Gr.10
11885	12093	12208	12312	12416	12520	12624	12728	12832	12936	13039	13143

Leather
 LC
 14286

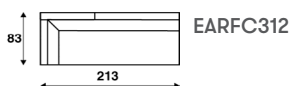
EARFC312 mare fix cushion connection right
EARFC313 mare fix cushion connection left

Product Options

Seat Height	Base Finishes	Seat and Back Upholstery Finish
43 43cm	Powder Coated	Fabrics
45 45cm	Polished Stainless Steel	Leather

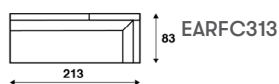
Notes Caps with felt
 Depending on the chosen upholstery, after a while pleats will appear. This can not be avoided
 Mare fixed cushion can be ordered in different compositions
 If Polished Stainless Steel is specified add 634

Price



COM	COL	Gr.1	Gr.2	Gr.3	Gr.4	Gr.5	Gr.6	Gr.7	Gr.8	Gr.9	Gr.10
11885	12093	12208	12312	12416	12520	12624	12728	12832	12936	13039	13143

Leather
LC
 14286



COM	COL	Gr.1	Gr.2	Gr.3	Gr.4	Gr.5	Gr.6	Gr.7	Gr.8	Gr.9	Gr.10
11885	12093	12208	12312	12416	12520	12624	12728	12832	12936	13039	13143

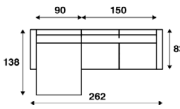
Leather
LC
 14286

EARFC350 mare fix cushion

Product Options

Seat Height	Armrest Size	Base Finishes	Seat and Back Upholstery Finish
43 43cm	12 12cm width	Powder Coated	Fabrics
45 45cm	21 21cm width	Polished Stainless Steel	Leather

Notes Caps with felt
 Depending on the chosen upholstery, after a while pleats will appear. This can not be avoided
 Mare fixed cushion can be ordered in different compositions
 If Polished Stainless Steel is specified add 952
 If Armrest Size, (21) is specified add 665



EARFC350

Price

COM	COL	Gr.1	Gr.2	Gr.3	Gr.4	Gr.5	Gr.6	Gr.7	Gr.8	Gr.9	Gr.10
19607	19815	20147	20324	20501	20677	20854	21030	21207	21384	21560	21737

Leather

LC
 23680

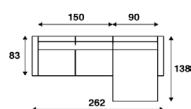
EARFC351 mare fix cushion

Product Options

Seat Height	Armrest Size	Base Finishes	Seat and Back Upholstery Finish
43 43cm	12 12cm width	Powder Coated	Fabrics
45 45cm	21 21cm width	Polished Stainless Steel	Leather

Notes Caps with felt
 Depending on the chosen upholstery, after a while pleats will appear. This can not be avoided
 Mare fixed cushion can be ordered in different compositions
 If Polished Stainless Steel is specified add 952
 If Armrest Size, (21) is specified add 665

Price



EARFC351

COM	COL	Gr.1	Gr.2	Gr.3	Gr.4	Gr.5	Gr.6	Gr.7	Gr.8	Gr.9	Gr.10
19607	19815	20147	20324	20501	20677	20854	21030	21207	21384	21560	21737

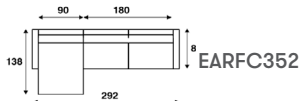
Leather
LC
 23680

EARFC352 mare fix cushion

Product Options

Seat Height	Armrest Size	Base Finishes	Seat and Back Upholstery Finish
43 43cm	12 12cm width	Powder Coated	Fabrics
45 45cm	21 21cm width	Polished Stainless Steel	Leather

Notes Caps with felt
 Depending on the chosen upholstery, after a while pleats will appear. This can not be avoided
 Mare fixed cushion can be ordered in different compositions
 If Polished Stainless Steel is specified add 952
 If Armrest Size, (21) is specified add 666



Price

COM	COL	Gr.1	Gr.2	Gr.3	Gr.4	Gr.5	Gr.6	Gr.7	Gr.8	Gr.9	Gr.10
20272	20480	20812	20989	21165	21342	21519	21695	21872	22049	22225	22402

Leather
 LC
 24345

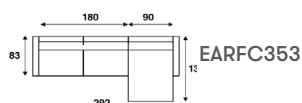
EARFC353 mare fix cushion

Product Options

Seat Height	Armrest Size	Base Finishes	Seat and Back Upholstery Finish
43 43cm	12 12cm width	Powder Coated	Fabrics
45 45cm	21 21cm width	Polished Stainless Steel	Leather

Notes Caps with felt
 Depending on the chosen upholstery, after a while pleats will appear. This can not be avoided
 Mare fixed cushion can be ordered in different compositions
 If Polished Stainless Steel is specified add 952
 If Armrest Size, (21) is specified add 666

Price



COM	COL	Gr.1	Gr.2	Gr.3	Gr.4	Gr.5	Gr.6	Gr.7	Gr.8	Gr.9	Gr.10
20272	20480	20812	20989	21165	21342	21519	21695	21872	22049	22225	22402

Leather
 LC
 24345

EARFC354 mare fix cushion

Product Options

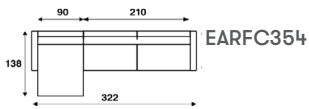
Seat Height	Armrest Size	Base Finishes	Seat and Back Upholstery Finish
43 43cm	12 12cm width	Powder Coated	Fabrics
45 45cm	21 21cm width	Polished Stainless Steel	Leather

Notes Caps with felt
 Depending on the chosen upholstery, after a while pleats will appear. This can not be avoided
 Mare fixed cushion can be ordered in different compositions
 If Polished Stainless Steel is specified add 952
 If Armrest Size, (21) is specified add 666

Price

COM	COL	Gr.1	Gr.2	Gr.3	Gr.4	Gr.5	Gr.6	Gr.7	Gr.8	Gr.9	Gr.10
21450	21658	22094	22292	22489	22687	22884	23081	23279	23476	23674	23871

Leather
 LC
 26043



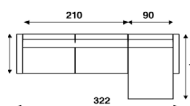
EARFC355 mare fix cushion

Product Options

Seat Height		Armrest Size		Base Finishes	Seat and Back Upholstery Finish
43	43cm	12	12cm width	Powder Coated	Fabrics
45	45cm	21	21cm width	Polished Stainless Steel	Leather

Notes Caps with felt
 Depending on the chosen upholstery, after a while pleats will appear. This can not be avoided
 Mare fixed cushion can be ordered in different compositions
 If Polished Stainless Steel is specified add 952
 If Armrest Size, (21) is specified add 665

Price



EARFC355

COM	COL	Gr.1	Gr.2	Gr.3	Gr.4	Gr.5	Gr.6	Gr.7	Gr.8	Gr.9	Gr.10
21450	21658	22094	22292	22489	22687	22884	23081	23279	23476	23674	23871

Leather
 LC
 26043

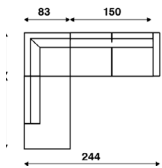
EARFC356 mare fix cushion

Product Options

Seat Height	Armrest Size	Base Finishes	Seat and Back Upholstery Finish
43 43cm	12 12cm width	Powder Coated	Fabrics
45 45cm	21 21cm width	Polished Stainless Steel	Leather

Notes Caps with felt
 Depending on the chosen upholstery, after a while pleats will appear. This can not be avoided
 Mare fixed cushion can be ordered in different compositions
 If Polished Stainless Steel is specified add 1586
 If Armrest Size, (21) is specified add 335

Price



EARFC356

COM	COL	Gr.1	Gr.2	Gr.3	Gr.4	Gr.5	Gr.6	Gr.7	Gr.8	Gr.9	Gr.10
23071	23279	23715	23913	24110	24307	24505	24702	24900	25097	25294	25492

Leather
 LC
 27663

EARFC357 mare fix cushion

Product Options

Seat Height	Armrest Size	Base Finishes	Seat and Back Upholstery Finish
43 43cm	12 12cm width	Powder Coated	Fabrics
45 45cm	21 21cm width	Polished Stainless Steel	Leather

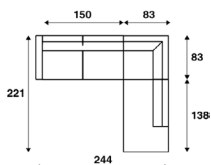
Notes Caps with felt
 Depending on the chosen upholstery, after a while pleats will appear. This can not be avoided
 Mare fixed cushion can be ordered in different compositions
 If Polished Stainless Steel is specified add 1586
 If Armrest Size, (21) is specified add 335

Price

EARFC357

COM	COL	Gr.1	Gr.2	Gr.3	Gr.4	Gr.5	Gr.6	Gr.7	Gr.8	Gr.9	Gr.10
23071	23279	23715	23913	24110	24307	24505	24702	24900	25097	25294	25492

Leather
 LC
 27663



EARFC358 mare fix cushion

Product Options

Seat Height	Armrest Size	Base Finishes	Seat and Back Upholstery Finish
43 43cm	12 12cm width	Powder Coated	Fabrics
45 45cm	21 21cm width	Polished Stainless Steel	Leather

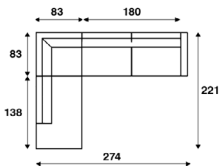
Notes Caps with felt
 Depending on the chosen upholstery, after a while pleats will appear. This can not be avoided
 Mare fixed cushion can be ordered in different compositions
 If Polished Stainless Steel is specified add 1586
 If Armrest Size, (21) is specified add 334

Price

EARFC358

COM	COL	Gr.1	Gr.2	Gr.3	Gr.4	Gr.5	Gr.6	Gr.7	Gr.8	Gr.9	Gr.10
23737	23945	24381	24579	24776	24973	25171	25368	25566	25763	25960	26158

Leather
 LC
 28329



EARFC359 mare fix cushion

Product Options

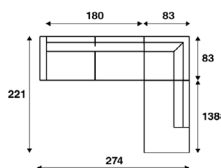
Seat Height	Armrest Size	Base Finishes	Seat and Back Upholstery Finish
43 43cm	12 12cm width	Powder Coated	Fabrics
45 45cm	21 21cm width	Polished Stainless Steel	Leather

Notes Caps with felt
 Depending on the chosen upholstery, after a while pleats will appear. This can not be avoided
 Mare fixed cushion can be ordered in different compositions
 If Polished Stainless Steel is specified add 1586
 If Armrest Size, (21) is specified add 335

Price

EARFC359

COM	COL	Gr.1	Gr.2	Gr.3	Gr.4	Gr.5	Gr.6	Gr.7	Gr.8	Gr.9	Gr.10
23071	23279	23715	23913	24110	24307	24505	24702	24900	25097	25294	25492



Leather
 LC
 27663

EARFC360 mare fix cushion

Product Options

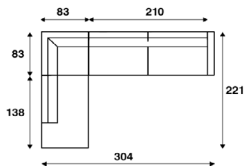
Seat Height	Armrest Size	Base Finishes	Seat and Back Upholstery Finish
43 43cm	12 12cm width	Powder Coated	Fabrics
45 45cm	21 21cm width	Polished Stainless Steel	Leather

Notes Caps with felt
 Depending on the chosen upholstery, after a while pleats will appear. This can not be avoided
 Mare fixed cushion can be ordered in different compositions
 If Polished Stainless Steel is specified add 1586
 If Armrest Size, (21) is specified add 334

Price

EARFC360

COM	COL	Gr.1	Gr.2	Gr.3	Gr.4	Gr.5	Gr.6	Gr.7	Gr.8	Gr.9	Gr.10
24915	25123	25643	25871	26100	26328	26557	26785	27014	27243	27471	27700



Leather
 LC
 30214

EARFC361 mare fix cushion

Product Options

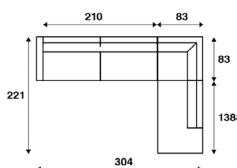
Seat Height	Armrest Size	Base Finishes	Seat and Back Upholstery Finish
43 43cm	12 12cm width	Powder Coated	Fabrics
45 45cm	21 21cm width	Polished Stainless Steel	Leather

Notes Caps with felt
 Depending on the chosen upholstery, after a while pleats will appear. This can not be avoided
 Mare fixed cushion can be ordered in different compositions
 If Polished Stainless Steel is specified add 1586
 If Armrest Size, (21) is specified add 665

Price

COM	COL	Gr.1	Gr.2	Gr.3	Gr.4	Gr.5	Gr.6	Gr.7	Gr.8	Gr.9	Gr.10
24915	25123	25643	25871	26100	26328	26557	26785	27014	27243	27471	27700

EARFC361



Leather
 LC
 30214

EARFC362 mare fix cushion

Product Options

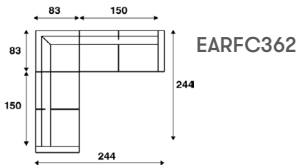
Seat Height	Armrest Size	Base Finishes	Seat and Back Upholstery Finish
43 43cm	12 12cm width	Powder Coated	Fabrics
45 45cm	21 21cm width	Polished Stainless Steel	Leather

Notes Caps with felt
 Depending on the chosen upholstery, after a while pleats will appear. This can not be avoided
 Mare fixed cushion can be ordered in different compositions
 If Polished Stainless Steel is specified add 1586
 If Armrest Size, (21) is specified add 665

Price

COM	COL	Gr.1	Gr.2	Gr.3	Gr.4	Gr.5	Gr.6	Gr.7	Gr.8	Gr.9	Gr.10
25038	25246	25765	25994	26222	26451	26679	26908	27137	27365	27594	27822

Leather
 LC
 30337



EARFC363 mare fix cushion

Product Options

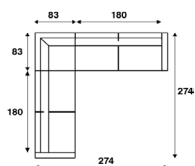
Seat Height	Armrest Size	Base Finishes	Seat and Back Upholstery Finish
43 43cm	12 12cm width	Powder Coated	Fabrics
45 45cm	21 21cm width	Polished Stainless Steel	Leather

Notes Caps with felt
 Depending on the chosen upholstery, after a while pleats will appear. This can not be avoided
 Mare fixed cushion can be ordered in different compositions
 If Polished Stainless Steel is specified add 1586
 If Armrest Size, (21) is specified add 665

Price

COM	COL	Gr.1	Gr.2	Gr.3	Gr.4	Gr.5	Gr.6	Gr.7	Gr.8	Gr.9	Gr.10
26366	26573	27172	27401	27629	27858	28086	28315	28543	28772	29001	29229

Leather
 LC
 31744



EARFC364 mare fix cushion

Product Options

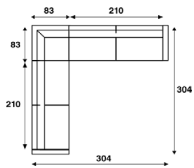
Seat Height	Armrest Size	Base Finishes	Seat and Back Upholstery Finish
43 43cm	12 12cm width	Powder Coated	Fabrics
45 45cm	21 21cm width	Polished Stainless Steel	Leather

Notes Caps with felt
 Depending on the chosen upholstery, after a while pleats will appear. This can not be avoided
 Mare fixed cushion can be ordered in different compositions
 If Polished Stainless Steel is specified add 1586
 If Armrest Size, (21) is specified add 665

Price

COM	COL	Gr.1	Gr.2	Gr.3	Gr.4	Gr.5	Gr.6	Gr.7	Gr.8	Gr.9	Gr.10
28725	28933	29629	29920	30211	30502	30793	31084	31375	31666	31957	32247

Leather
 LC
 35448



EARFC364

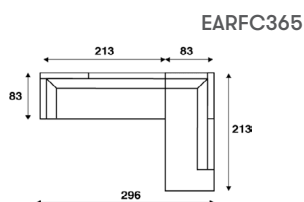
EARFC365 mare fix cushion
EARFC366 mare fix cushion

Product Options

Seat Height	Base Finishes	Seat and Back Upholstery Finish
43 43cm	Powder Coated	Fabrics
45 45cm	Polished Stainless Steel	Leather

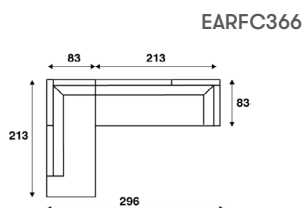
Notes Caps with felt
 Depending on the chosen upholstery, after a while pleats will appear. This can not be avoided
 Mare fixed cushion can be ordered in different compositions
 If Polished Stainless Steel is specified add 952

Price



COM	COL	Gr.1	Gr.2	Gr.3	Gr.4	Gr.5	Gr.6	Gr.7	Gr.8	Gr.9	Gr.10
23769	23977	24413	24611	24808	25006	25203	25400	25598	25795	25993	26190

Leather
 LC
 28362



COM	COL	Gr.1	Gr.2	Gr.3	Gr.4	Gr.5	Gr.6	Gr.7	Gr.8	Gr.9	Gr.10
23769	23977	24413	24611	24808	25006	25203	25400	25598	25795	25993	26190

Leather
 LC
 28362

EARFC367 mare fix cushion

Product Options

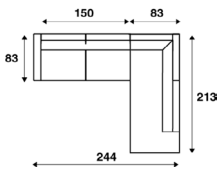
Seat Height	Armrest Size	Base Finishes	Seat and Back Upholstery Finish
43 43cm	12 12cm width	Powder Coated	Fabrics
45 45cm	21 21cm width	Polished Stainless Steel	Leather

Notes Caps with felt
 Depending on the chosen upholstery, after a while pleats will appear. This can not be avoided
 Mare fixed cushion can be ordered in different compositions
 If Polished Stainless Steel is specified add 952
 If Armrest Size, (21) is specified add 334

Price

EARFC367

COM	COL	Gr.1	Gr.2	Gr.3	Gr.4	Gr.5	Gr.6	Gr.7	Gr.8	Gr.9	Gr.10
21686	21894	22330	22528	22725	22922	23120	23317	23515	23712	23909	24107



Leather
 LC
 26278

EARFC368 mare fix cushion

Product Options

Seat Height	Armrest Size	Base Finishes	Seat and Back Upholstery Finish
43 43cm	12 12cm width	Powder Coated	Fabrics
45 45cm	21 21cm width	Polished Stainless Steel	Leather

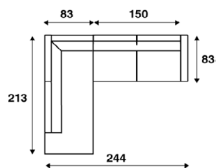
Notes Caps with felt
 Depending on the chosen upholstery, after a while pleats will appear. This can not be avoided
 Mare fixed cushion can be ordered in different compositions
 If Polished Stainless Steel is specified add 952
 If Armrest Size, (21) is specified add 334

Price

COM	COL	Gr.1	Gr.2	Gr.3	Gr.4	Gr.5	Gr.6	Gr.7	Gr.8	Gr.9	Gr.10
21686	21894	22330	22528	22725	22922	23120	23317	23515	23712	23909	24107

Leather
 LC
 26278

EARFC368



EARFC369 mare fix cushion

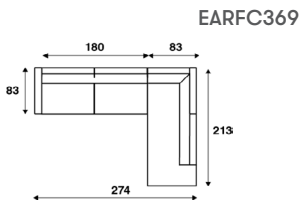
Product Options

Seat Height	Armrest Size	Base Finishes	Seat and Back Upholstery Finish
43 43cm	12 12cm width	Powder Coated	Fabrics
45 45cm	21 21cm width	Polished Stainless Steel	Leather

Notes Caps with felt
 Depending on the chosen upholstery, after a while pleats will appear. This can not be avoided
 Mare fixed cushion can be ordered in different compositions
 If Polished Stainless Steel is specified add 952
 If Armrest Size, (21) is specified add 335

Price

COM	COL	Gr.1	Gr.2	Gr.3	Gr.4	Gr.5	Gr.6	Gr.7	Gr.8	Gr.9	Gr.10
22351	22559	22995	23193	23390	23587	23785	23982	24180	24377	24574	24772



Leather
 LC
 26943

EARFC370 mare fix cushion

Product Options

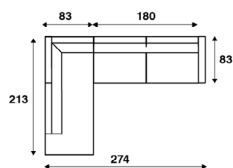
Seat Height	Armrest Size	Base Finishes	Seat and Back Upholstery Finish
43 43cm	12 12cm width	Powder Coated	Fabrics
45 45cm	21 21cm width	Polished Stainless Steel	Leather

Notes Caps with felt
 Depending on the chosen upholstery, after a while pleats will appear. This can not be avoided
 Mare fixed cushion can be ordered in different compositions
 If Polished Stainless Steel is specified add 952
 If Armrest Size, (21) is specified add 335

Price

EARFC370

COM	COL	Gr.1	Gr.2	Gr.3	Gr.4	Gr.5	Gr.6	Gr.7	Gr.8	Gr.9	Gr.10
22351	22559	22995	23193	23390	23587	23785	23982	24180	24377	24574	24772



Leather
 LC
 26943

EARFC371 mare fix cushion

Product Options

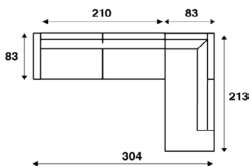
Seat Height	Armrest Size	Base Finishes	Seat and Back Upholstery Finish
43 43cm	12 12cm width	Powder Coated	Fabrics
45 45cm	21 21cm width	Polished Stainless Steel	Leather

Notes Caps with felt
 Depending on the chosen upholstery, after a while pleats will appear. This can not be avoided
 Mare fixed cushion can be ordered in different compositions
 If Polished Stainless Steel is specified add 952
 If Armrest Size, (21) is specified add 335

Price

EARFC371

COM	COL	Gr.1	Gr.2	Gr.3	Gr.4	Gr.5	Gr.6	Gr.7	Gr.8	Gr.9	Gr.10
22351	22559	22995	23193	23390	23587	23785	23982	24180	24377	24574	24772



Leather
 LC
 26943

EARFC372 mare fix cushion

Product Options

Seat Height	Armrest Size	Base Finishes	Seat and Back Upholstery Finish
43 43cm	12 12cm width	Powder Coated	Fabrics
45 45cm	21 21cm width	Polished Stainless Steel	Leather

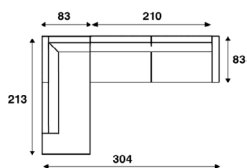
Notes Caps with felt
 Depending on the chosen upholstery, after a while pleats will appear. This can not be avoided
 Mare fixed cushion can be ordered in different compositions
 If Polished Stainless Steel is specified add 952
 If Armrest Size, (21) is specified add 335

Price

EARFC372

COM	COL	Gr.1	Gr.2	Gr.3	Gr.4	Gr.5	Gr.6	Gr.7	Gr.8	Gr.9	Gr.10
23529	23737	24214	24411	24609	24806	25004	25201	25398	25596	25793	25991

Leather
 LC
 28162



EARFC373 mare fix cushion

Product Options

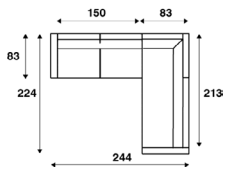
Seat Height	Armrest Size	Base Finishes	Seat and Back Upholstery Finish
43 43cm	12 12cm width	Powder Coated	Fabrics
45 45cm	21 21cm width	Polished Stainless Steel	Leather

Notes Caps with felt
 Depending on the chosen upholstery, after a while pleats will appear. This can not be avoided
 Mare fixed cushion can be ordered in different compositions
 If Polished Stainless Steel is specified add 952
 If Armrest Size, (21) is specified add 666

Price

COM	COL	Gr.1	Gr.2	Gr.3	Gr.4	Gr.5	Gr.6	Gr.7	Gr.8	Gr.9	Gr.10
22410	22618	23070	23267	23465	23662	23860	24057	24254	24452	24649	24847

EARFC373



Leather
 LC
 27018

EARFC374 mare fix cushion

Product Options

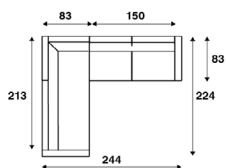
Seat Height	Armrest Size	Base Finishes	Seat and Back Upholstery Finish
43 43cm	12 12cm width	Powder Coated	Fabrics
45 45cm	21 21cm width	Polished Stainless Steel	Leather

Notes Caps with felt
 Depending on the chosen upholstery, after a while pleats will appear. This can not be avoided
 Mare fixed cushion can be ordered in different compositions
 If Polished Stainless Steel is specified add 952
 If Armrest Size, (21) is specified add 666

Price

EARFC374

COM	COL	Gr.1	Gr.2	Gr.3	Gr.4	Gr.5	Gr.6	Gr.7	Gr.8	Gr.9	Gr.10
22410	22618	23070	23267	23465	23662	23860	24057	24254	24452	24649	24847



Leather
 LC
 27018

EARFC375 mare fix cushion

Product Options

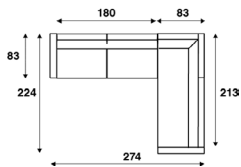
Seat Height	Armrest Size	Base Finishes	Seat and Back Upholstery Finish
43 43cm	12 12cm width	Powder Coated	Fabrics
45 45cm	21 21cm width	Polished Stainless Steel	Leather

Notes Caps with felt
 Depending on the chosen upholstery, after a while pleats will appear. This can not be avoided
 Mare fixed cushion can be ordered in different compositions
 If Polished Stainless Steel is specified add 952
 If Armrest Size, (21) is specified add 665

Price

COM	COL	Gr.1	Gr.2	Gr.3	Gr.4	Gr.5	Gr.6	Gr.7	Gr.8	Gr.9	Gr.10
23076	23284	23761	23958	24156	24353	24551	24748	24945	25143	25340	25538

EARFC375



Leather
 LC
 27709

EARFC376 mare fix cushion

Product Options

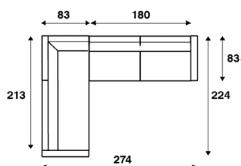
Seat Height	Armrest Size	Base Finishes	Seat and Back Upholstery Finish
43 43cm	12 12cm width	Powder Coated	Fabrics
45 45cm	21 21cm width	Polished Stainless Steel	Leather

Notes Caps with felt
 Depending on the chosen upholstery, after a while pleats will appear. This can not be avoided
 Mare fixed cushion can be ordered in different compositions
 If Polished Stainless Steel is specified add 952
 If Armrest Size, (21) is specified add 665

Price

EARFC376

COM	COL	Gr.1	Gr.2	Gr.3	Gr.4	Gr.5	Gr.6	Gr.7	Gr.8	Gr.9	Gr.10
23076	23284	23761	23958	24156	24353	24551	24748	24945	25143	25340	25538



Leather
 LC
 27709

EARFC377 mare fix cushion

Product Options

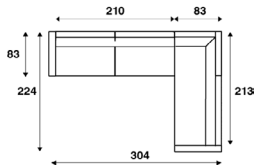
Seat Height	Armrest Size	Base Finishes	Seat and Back Upholstery Finish
43 43cm	12 12cm width	Powder Coated	Fabrics
45 45cm	21 21cm width	Polished Stainless Steel	Leather

Notes Caps with felt
 Depending on the chosen upholstery, after a while pleats will appear. This can not be avoided
 Mare fixed cushion can be ordered in different compositions
 If Polished Stainless Steel is specified add 952
 If Armrest Size, (21) is specified add 665

Price

EARFC377

COM	COL	Gr.1	Gr.2	Gr.3	Gr.4	Gr.5	Gr.6	Gr.7	Gr.8	Gr.9	Gr.10
24254	24462	24988	25217	25445	25674	25902	26131	26359	26588	26817	27045



Leather
 LC
 29560

EARFC378 mare fix cushion

Product Options

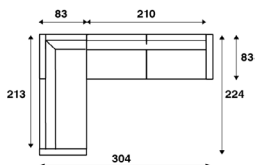
Seat Height	Armrest Size	Base Finishes	Seat and Back Upholstery Finish
43 43cm	12 12cm width	Powder Coated	Fabrics
45 45cm	21 21cm width	Polished Stainless Steel	Leather

Notes Caps with felt
 Depending on the chosen upholstery, after a while pleats will appear. This can not be avoided
 Mare fixed cushion can be ordered in different compositions
 If Polished Stainless Steel is specified add 952
 If Armrest Size, (21) is specified add 665

Price

EARFC378

COM	COL	Gr.1	Gr.2	Gr.3	Gr.4	Gr.5	Gr.6	Gr.7	Gr.8	Gr.9	Gr.10
24254	24462	24988	25217	25445	25674	25902	26131	26359	26588	26817	27045



Leather
 LC
 29560

EARFC379 mare fix cushion

Product Options

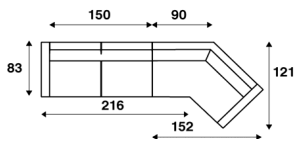
Seat Height	Armrest Size	Base Finishes	Seat and Back Upholstery Finish
43 43cm	12 12cm width	Powder Coated	Fabrics
45 45cm	21 21cm width	Polished Stainless Steel	Leather

Notes Caps with felt
 Depending on the chosen upholstery, after a while pleats will appear. This can not be avoided
 Mare fixed cushion can be ordered in different compositions
 If Polished Stainless Steel is specified add 1268
 If Armrest Size, (21) is specified add 666

Price

EARFC379

COM	COL	Gr.1	Gr.2	Gr.3	Gr.4	Gr.5	Gr.6	Gr.7	Gr.8	Gr.9	Gr.10
18764	18972	19351	19528	19705	19881	20058	20235	20411	20588	20764	20941



Leather
 LC
 22884

EARFC380 mare fix cushion

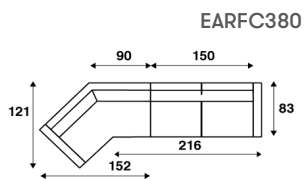
Product Options

Seat Height	Armrest Size	Base Finishes	Seat and Back Upholstery Finish
43 43cm	12 12cm width	Powder Coated	Fabrics
45 45cm	21 21cm width	Polished Stainless Steel	Leather

Notes Caps with felt
 Depending on the chosen upholstery, after a while pleats will appear. This can not be avoided
 Mare fixed cushion can be ordered in different compositions
 If Polished Stainless Steel is specified add 1268
 If Armrest Size, (21) is specified add 666

Price

COM	COL	Gr.1	Gr.2	Gr.3	Gr.4	Gr.5	Gr.6	Gr.7	Gr.8	Gr.9	Gr.10
18764	18972	19351	19528	19705	19881	20058	20235	20411	20588	20764	20941



Leather
 LC
 22884

EARFC381 mare fix cushion

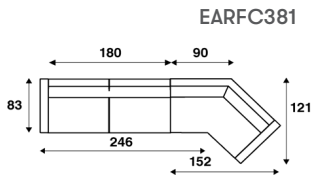
Product Options

Seat Height	Armrest Size	Base Finishes	Seat and Back Upholstery Finish
43 43cm	12 12cm width	Powder Coated	Fabrics
45 45cm	21 21cm width	Polished Stainless Steel	Leather

Notes Caps with felt
 Depending on the chosen upholstery, after a while pleats will appear. This can not be avoided
 Mare fixed cushion can be ordered in different compositions
 If Polished Stainless Steel is specified add 1268
 If Armrest Size, (21) is specified add 666

Price

COM	COL	Gr.1	Gr.2	Gr.3	Gr.4	Gr.5	Gr.6	Gr.7	Gr.8	Gr.9	Gr.10
19427	19635	20040	20279	20477	20674	20871	21069	21266	21464	21661	21858



Leather
 LC
 24030

EARFC382 mare fix cushion

Product Options

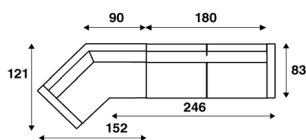
Seat Height	Armrest Size	Base Finishes	Seat and Back Upholstery Finish
43 43cm	12 12cm width	Powder Coated	Fabrics
45 45cm	21 21cm width	Polished Stainless Steel	Leather

Notes Caps with felt
 Depending on the chosen upholstery, after a while pleats will appear. This can not be avoided
 Mare fixed cushion can be ordered in different compositions
 If Polished Stainless Steel is specified add 1268
 If Armrest Size, (21) is specified add 666

Price

COM	COL	Gr.1	Gr.2	Gr.3	Gr.4	Gr.5	Gr.6	Gr.7	Gr.8	Gr.9	Gr.10
19427	19635	20040	20238	20435	20632	20830	21027	21225	21422	21620	21817

EARFC382



Leather
 LC
 23988

EARFC383 mare fix cushion

Product Options

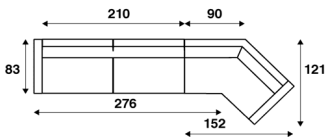
Seat Height	Armrest Size	Base Finishes	Seat and Back Upholstery Finish
43 43cm	12 12cm width	Powder Coated	Fabrics
45 45cm	21 21cm width	Polished Stainless Steel	Leather

Notes Caps with felt
 Depending on the chosen upholstery, after a while pleats will appear. This can not be avoided
 Mare fixed cushion can be ordered in different compositions
 If Polished Stainless Steel is specified add 1268
 If Armrest Size, (21) is specified add 665

Price

COM	COL	Gr.1	Gr.2	Gr.3	Gr.4	Gr.5	Gr.6	Gr.7	Gr.8	Gr.9	Gr.10
20609	20816	21253	21450	21648	21845	22042	22240	22437	22635	22832	23029

EARFC383



Leather
 LC
 25201

EARFC384 mare fix cushion

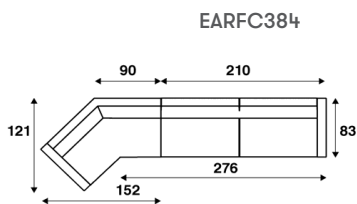
Product Options

Seat Height	Armrest Size	Base Finishes	Seat and Back Upholstery Finish
43 43cm	12 12cm width	Powder Coated	Fabrics
45 45cm	21 21cm width	Polished Stainless Steel	Leather

Notes Caps with felt
 Depending on the chosen upholstery, after a while pleats will appear. This can not be avoided
 Mare fixed cushion can be ordered in different compositions
 If Polished Stainless Steel is specified add 1268
 If Armrest Size, (21) is specified add 665

Price

COM	COL	Gr.1	Gr.2	Gr.3	Gr.4	Gr.5	Gr.6	Gr.7	Gr.8	Gr.9	Gr.10
20609	20816	21253	21450	21648	21845	22042	22240	22437	22635	22832	23029



Leather
 LC
 25201

nina by artifort

features

A contemporary, luxurious design. Elegant and comfortable. For meeting rooms and dining rooms. The rounded, well-fitted back makes the chair comfortable as active seating or in a more relaxed position.

The round chair fits the contour of the human body. As a result, both an active and relaxed sitting position can be adopted. Available in four versions.

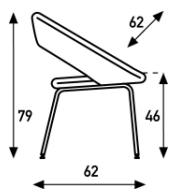
EARNA nina chair 4 legged

Product Options

Base Height		Felt Gliders		Base Finishes		Upholstery Finishes	
S	46cm	Y	Yes	Powder Coated		Fabrics	
H	47.5cm	N	No	Chrome		Leather	

Notes 4 leg base in powder coat; with black floor caps with plastic sliding surface
 4 leg in chrome; with chrome floor caps with plastic sliding surface
 If Felt Gliders (Y) is specified add 94
 If Chrome is specified add 281

Price



EARNAH

COM	COL	Gr.1	Gr.2	Gr.3	Gr.4	Gr.5	Gr.6	Gr.7	Gr.8	Gr.9	Gr.10
2760	2863	2863	2915	2967	3019	3071	3123	3175	3227	3279	3331

Leather Leather

LC	LD
3902	3954

EARNAS

COM	COL	Gr.1	Gr.2	Gr.3	Gr.4	Gr.5	Gr.6	Gr.7	Gr.8	Gr.9	Gr.10
2573	2676	2676	2728	2780	2832	2884	2936	2988	3040	3092	3144

Leather Leather

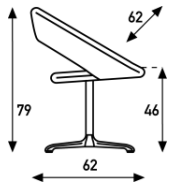
LC	LD
3715	3767

EARNB nina c chair cross base non swiveling

Product Options

Base Finishes	Upholstery Finish
Powder Coated Aluminum Polished (tube in chrome)	Fabrics Leather

Notes If Aluminum Polished (tube in chrome) is specified add 239



EARNB

Price

COM	COL	Gr.1	Gr.2	Gr.3	Gr.4	Gr.5	Gr.6	Gr.7	Gr.8	Gr.9	Gr.10
2779	2883	2883	2935	2987	3039	3091	3143	3195	3247	3299	3351

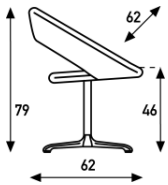
Leather LC	Leather LD
3922	3974

EARNC nina c chair cross base swiveling with return mechanism

Product Options

Base Finishes	Upholstery Finishes
Powder Coated Aluminum Polished (tube in chrome)	Fabrics Leather

Notes If Aluminum Polished (tube in chrome) is specified add 239



EARNC

Price

COM	COL	Gr.1	Gr.2	Gr.3	Gr.4	Gr.5	Gr.6	Gr.7	Gr.8	Gr.9	Gr.10
2847	2951	2951	3003	3055	3107	3159	3211	3262	3314	3366	3418

Leather LC	Leather LD
3990	4042

EARN D nina D chair 5-legged height adjustable

Product Options

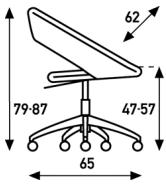
Castors Style	Base Finishes	Upholstery Finish
Hard Soft	Powder Coated Polished Aluminum	Fabrics Leather

Notes If the base is polished aluminum, gas spring and castor caps always chrome
Castors standard soft tread breaking

Price

COM	COL	Gr.1	Gr.2	Gr.3	Gr.4	Gr.5	Gr.6	Gr.7	Gr.8	Gr.9	Gr.10
2807	2911	2911	2963	3015	3067	3119	3171	3223	3275	3327	3379

Leather	Leather
LC	LD
3950	4002



EARN D

pala by artifort

features

Pala is a fully upholstered armchair on a pedestal designed by Italian designer Luca Nichetto. The design follows the shape of a human body and combines Artifort's heritage with a contemporary approach. The striking Pala works well in homes, hotels, waiting areas and lounges.

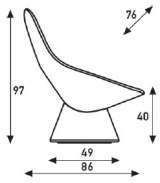
This modern and characteristic armchair invites you to leave everyday hustle and bustle for what it is. It's a place to relax and take time for yourself. The armchair can be complemented with a matching footstool and a matching side table, and also stands fine on its own.

EARPA pala lounge chair

Product Options

Style	Inner Seat & Back Upholstery Finishes	Outer Back & Base Upholstery Finishes
S Swivel	Fabrics	Fabrics
N Non-Swivel		

Price



EARPAS

COM	COL	Gr.1	Gr.2	Gr.3	Gr.4	Gr.5	Gr.6	Gr.7	Gr.8	Gr.9	Gr.10
8625	8729	8874	8978	9082	9186	9290	9394	9497	9601	9705	9809

EARPAN

COM	COL	Gr.1	Gr.2	Gr.3	Gr.4	Gr.5	Gr.6	Gr.7	Gr.8	Gr.9	Gr.10
8501	8605	8750	8854	8958	9062	9170	9270	9374	9478	9582	9686

EARPB pala ottoman

Product Options

Seat Top Upholstery Finishes	Base Upholstery Finish
Fabrics	Fabrics



EARPB

Price

COM	COL	Gr.1	Gr.2	Gr.3	Gr.4	Gr.5	Gr.6	Gr.7	Gr.8	Gr.9	Gr.10
2457	2509	2509	2561	2613	2665	2717	2769	2821	2873	2925	2977

shark by artifort

features

Shark is a model that acquired its name because its profile resembled that of the feared predator. However, you have nothing to fear from this shark. On the contrary. It's an extremely comfortable chair to sit on. Sturdy with extra back support. A delightful chair for a long evening around the table, or for a productive meeting.

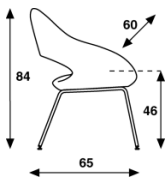
EARSHRK1 shark chair 4 legged

Product Options

Base Height		Felt Gliders		Base Finishes		Upholstery Finish	
S	46cm	Y	Yes	Powder Coated		Fabrics	
H	47.5cm	N	No	Chrome			

Notes If Felt Gliders (Y), is specified add 83
If Chrome base is specified add 166

Price



EARSHRK1S

EARSHRK1H

COM	COL	Gr.1	Gr.2	Gr.3	Gr.4	Gr.5	Gr.6	Gr.7	Gr.8	Gr.9	Gr.10
2719	2771	2823	2854	2885	2916	2948	2979	3010	3041	3072	3103
COM	COL	Gr.1	Gr.2	Gr.3	Gr.4	Gr.5	Gr.6	Gr.7	Gr.8	Gr.9	Gr.10
2926	2978	3030	3061	3092	3123	3154	3186	3217	3248	3279	3310

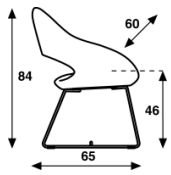
EARSHRK2 shark steel wire sled

Product Options

Base Height		Felt Gliders		Base Finishes		Upholstery Finish	
S	46cm	Y	Yes	Powder Coated		Fabrics	
H	47.5cm	N	No	Chrome			

Notes If Felt Gliders (N), is specified add 42
 If Felt Gliders (Y), is specified add 83
 If Chrome base is specified add 166

Price



EARSHRK2S

EARSHRK2H

COM	COL	Gr.1	Gr.2	Gr.3	Gr.4	Gr.5	Gr.6	Gr.7	Gr.8	Gr.9	Gr.10
2719	2771	2823	2854	2885	2916	2948	2979	3010	3041	3072	3103
COM	COL	Gr.1	Gr.2	Gr.3	Gr.4	Gr.5	Gr.6	Gr.7	Gr.8	Gr.9	Gr.10
2926	2978	3030	3061	3092	3123	3154	3186	3217	3248	3279	3310

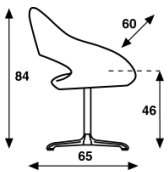
EARSHRK3 shark chair cross base non swiveling

EARSHRK4 shark chair cross base swiveling with return mechanism

Product Options

Back Plastic Felt Gliders	Base Finishes	Upholstery Finish
Y Yes	Powder Coated	Fabrics
N No	Aluminum Polished (tube in chrome)	

Notes If Back Plastic Felt Gliders (Y), is specified add 42



EARSHRK3

EARSHRK4

Price

COM	COL	Gr.1	Gr.2	Gr.3	Gr.4	Gr.5	Gr.6	Gr.7	Gr.8	Gr.9	Gr.10
2926	2978	3030	3061	3092	3123	3154	3186	3217	3248	3279	3310
COM	COL	Gr.1	Gr.2	Gr.3	Gr.4	Gr.5	Gr.6	Gr.7	Gr.8	Gr.9	Gr.10
3136	3188	3240	3271	3302	3333	3364	3395	3427	3458	3489	3520

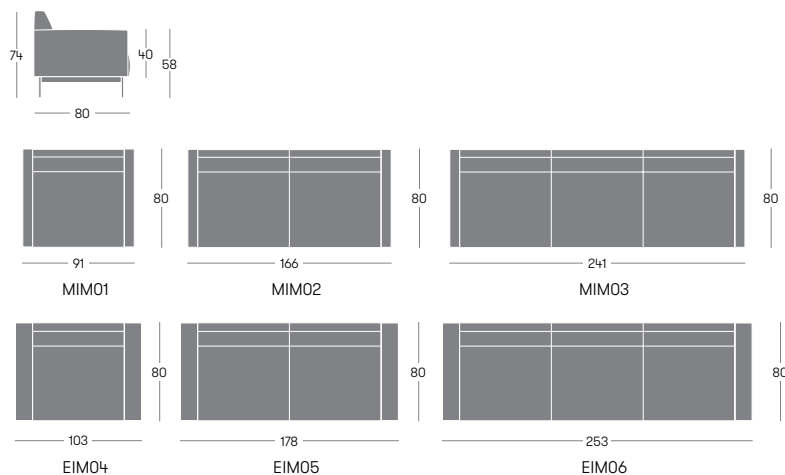
segis

hotel by segis

features

Hotel is a modular seating system characterized by a strong expressive versatility conceived for fluid, linear, and angular combinations. Comfortable pieces designed for enjoyable relaxation and conviviality. The collection includes two and three seater sofas plus an armchair; armrest options include an upholstered armrest in two sizes and a tablet arm for computer or other support. Joining tables between the seats or multifunctional tables complete the collection.

dimension



EIM hotel arm chairs & sofa - 2/3 seats

Product Options

Style	Upholstery Finish	Leg Finish
01 Armchair with Small Armrests 7cm 02 Sofa 2 Seats with Small Armrests 7cm 03 Sofa 3 Seats with Small Armrests 7cm 04 Armchair with Large Armrests 14cm 05 Sofa 2 Seats with Large Armrests 14cm 06 Sofa 3 Seats with Large Armrests 14cm	Fabrics	Powder Coated Finishes

Price

	COM	COL	Gr.1	Gr.2	Gr.3	Gr.4	Gr.5	Gr.6	Gr.7	Gr.8	Gr.9	Gr.10
EIM01	2874	3030	3071	3175	3279	3383	3487	3591	3695	3799	3902	4006

Leather LC	Leather D
5149	5253

	COM	COL	Gr.1	Gr.2	Gr.3	Gr.4	Gr.5	Gr.6	Gr.7	Gr.8	Gr.9	Gr.10
EIM02	4731	4886	5072	5176	5280	5384	5488	5592	5696	5800	5904	6007

Leather LC	Leather D
7150	7254

	COM	COL	Gr.1	Gr.2	Gr.3	Gr.4	Gr.5	Gr.6	Gr.7	Gr.8	Gr.9	Gr.10
EIM03	6507	6663	6948	7052	7156	7259	7363	7467	7571	7675	7779	7883

Leather LC	Leather D
9026	9130

	COM	COL	Gr.1	Gr.2	Gr.3	Gr.4	Gr.5	Gr.6	Gr.7	Gr.8	Gr.9	Gr.10
EIM04	3027	3182	3224	3328	3432	3536	3640	3744	3847	3951	4055	4159

Leather LC	Leather D
5302	5406

	COM	COL	Gr.1	Gr.2	Gr.3	Gr.4	Gr.5	Gr.6	Gr.7	Gr.8	Gr.9	Gr.10
EIM05	4883	5039	5225	5329	5433	5537	5641	5745	5849	5952	6056	6160

Leather LC	Leather D
7303	7407

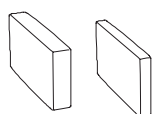
EIM **hotel arm chairs & sofa - 2/3 seats (continued)**

EIM06	COM	COL	Gr.1	Gr.2	Gr.3	Gr.4	Gr.5	Gr.6	Gr.7	Gr.8	Gr.9	Gr.10
	6655	6811	7095	7199	7303	7407	7511	7615	7719	7823	7927	8030
	Leather	Leather										
	LC	D										
	9173	9277										

EIMB hotel modular elements (armrest - upholstered)

Product Options

Style		Upholstery Finish
L	Large Armrest - 14 × 80cm rivestito	Fabrics
S	Small Armrest - 7 × 80cm rivestito	



EIMBL

Price

COM	COL	Gr.1	Gr.2	Gr.3	Gr.4	Gr.5	Gr.6	Gr.7	Gr.8	Gr.9	Gr.10
391	443	443	495	547	598	650	702	754	806	858	910

Leather Leather

LC	D
1482	1534

EIMBS

COM	COL	Gr.1	Gr.2	Gr.3	Gr.4	Gr.5	Gr.6	Gr.7	Gr.8	Gr.9	Gr.10
314	366	366	418	470	522	574	625	677	729	781	833

Leather Leather

LC	D
1405	1457

EIMP hotel modular elements (lounge / 1 ottoman)

Product Options

Style	Upholstery Finish	Leg Finish
2 Module 2 Seats (1 Lounge / 1 ottoman) 3 Module 3 Seats (2 Lounges / 1 ottoman)	Fabrics	Powder Coated Finishes



EIMP2

Price

COM	COL	Gr.1	Gr.2	Gr.3	Gr.4	Gr.5	Gr.6	Gr.7	Gr.8	Gr.9	Gr.10
3467	3623	3779	3883	3987	4091	4194	4298	4402	4506	4610	4714

Leather	Leather
LC	D
5857	5961



EIMP3

COM	COL	Gr.1	Gr.2	Gr.3	Gr.4	Gr.5	Gr.6	Gr.7	Gr.8	Gr.9	Gr.10
5244	5400	5659	5763	5867	5971	6075	6179	6283	6387	6491	6595

Leather	Leather
LC	D
7737	7841

EIMS hotel modular elements (lounge)

Product Options

Style	Upholstery Finish	Leg Finish
1 Module 1 Seats (1 Lounge)	Fabrics	Powder Coated Finishes
2 Module 2 Seats (2 Lounges)		
3 Module 3 Seats (3 Lounges)		
4 Angle Module		



EIMS1

Price

COM	COL	Gr.1	Gr.2	Gr.3	Gr.4	Gr.5	Gr.6	Gr.7	Gr.8	Gr.9	Gr.10
2245	2401	2443	2547	2650	2754	2858	2962	3066	3170	3274	3378

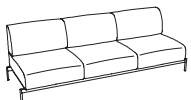
Leather LC	Leather D
4521	4625



EIMS2

COM	COL	Gr.1	Gr.2	Gr.3	Gr.4	Gr.5	Gr.6	Gr.7	Gr.8	Gr.9	Gr.10
4102	4258	4444	4548	4652	4756	4859	4963	5067	5171	5275	5379

Leather LC	Leather D
6522	6626



EIMS3

COM	COL	Gr.1	Gr.2	Gr.3	Gr.4	Gr.5	Gr.6	Gr.7	Gr.8	Gr.9	Gr.10
5879	6035	6319	6423	6527	6631	6735	6839	6943	7046	7150	7254

Leather LC	Leather D
8397	8501



EIMS4

COM	COL	Gr.1	Gr.2	Gr.3	Gr.4	Gr.5	Gr.6	Gr.7	Gr.8	Gr.9	Gr.10
2682	2838	2879	2983	3087	3191	3295	3399	3502	3606	3710	3814

Leather LC	Leather D
4957	5061

EIMQ hotel modular elements (lounge / 2 ottomans)

Product Options

Style	Upholstery Finish	Leg Finish
2 Module 2 seats (2 ottomans) 3 Module 3 seats (1 lounge/2 ottomans)	Fabrics	Powder Coated Finishes

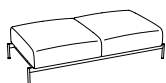
Price

EIMQ2	COM	COL	Gr.1	Gr.2	Gr.3	Gr.4	Gr.5	Gr.6	Gr.7	Gr.8	Gr.9	Gr.10
	2832	2988	3144	3248	3352	3456	3560	3664	3767	3871	3975	4079

Leather	Leather
LC	D
5222	5326

EIMQ3	COM	COL	Gr.1	Gr.2	Gr.3	Gr.4	Gr.5	Gr.6	Gr.7	Gr.8	Gr.9	Gr.10
	4604	4760	5019	5123	5227	5331	5435	5539	5643	5747	5851	5955

Leather	Leather
LC	D
7097	7201

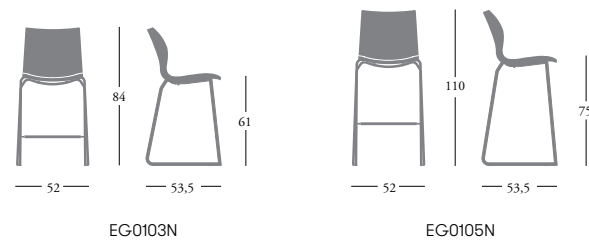
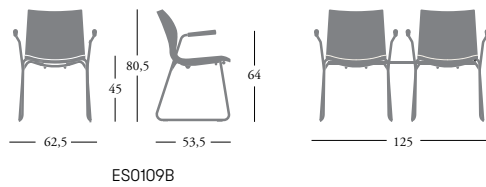
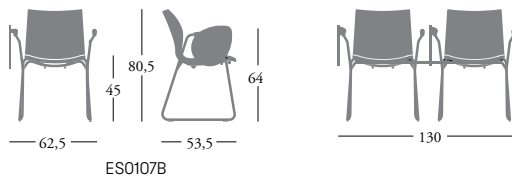


nami by segis

features

Stacking chair with or without armrests, polypropylene shell, with possibility of ganging device and writing tablet. Nami is ideal in training and conference areas, auditoriums, classrooms and healthcare facilities but it is also attractive in a retail setting, cafeteria and recreational space.

dimension



EG010 nami polypropylene stool

Product Options

Style	Seat & Back Finish	Seat Frame / Arm Finish
3N Without Arms, 61cm H	7F Black	08 Black
5N Without Arms, 75cm H	7P Grey	23 Dark Grey
	7Y Off-White	18 White
		68 Aluminium
		Chrome finish
		02 Chrome



Price

	Powder Coated	Chrome
EG0103N	565	607
EG0105N	609	659

ES010 nami polypropylene chair

Product Options

Style	Seat & Back Finish	Seat Frame / Arm Finish
7B With Arms	7F Black	08 Black
9B With Arms & Anti-Writing Tablet	7P Grey	23 Dark Grey
	7Y Off-White	18 White
		68 Aluminium
		Chrome finish
		02 Chrome
		Black Nickel
		07 Black Nickel



ES0107B

ES0109B

Price

	Powder Coated	Chrome
ES0107B	522	571
ES0109B	670	731

true design

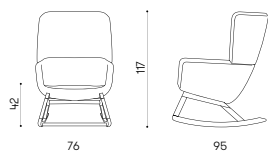
arca by true design

features

Coming from Studio Orlandini's inspiration, Arca defines a new concept of armchair for lounges and waiting areas, available in 3 backrest heights, which can be combined to many base typologies. The standard option, with low backrest, is ideal for quick waiting areas, large meeting rooms, while the medium back option, with backrest cushion, gives more prestige and comfort to the armchair. The High version gives the unique touch of design to this collection, with its embracing backrest for a break of full relax. Arca perfectly traces the new concept of "Smart Lounge", where waiting moments become great occasions for reflection, working or relaxing on the web; all versions of Arca can indeed be equipped with a large writing tablet, swivel around the arm.

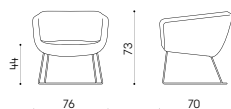
dimension

EAA909R
high backrest, w ooden rocking base



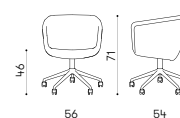
m 3,8k ◉ mq 6,5 📦 g 34 🛠 mc 0,9

EAA7095
low-backrest armchair, steel sled base



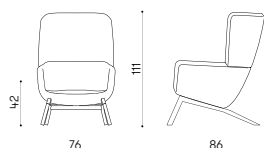
m 2,3k ◉ mq 4 📦 g 25 🛠 mc 0,55

EAA409C
5-spoke aluminium swivel base on casters



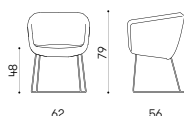
m 1,4k ◉ mq 2,7 📦 g 8m 🛠 c 0,22

EAA909S
high backrest, w ooden sled base



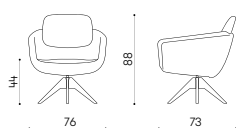
m 3,8k ◉ mq 6,5 📦 g 31 🛠 mc 0,9

EAA5095
steel sled base



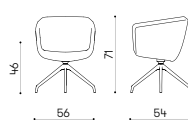
m 2,2k ◉ mq 4 📦 g 14 🛠 mc 0,3

EAA8099
mid-backrest, s wivel wooden base



m 2,8k ◉ mq 5 📦 g 30 🛠 mc 0,6

EAA4098
4-spoke aluminum swivel base



m 1,4k ◉ mq 2,7 📦 g 8m 🛠 c 0,22

EAA7095 arca lounge low backrest armchair, steel sled base

Product Options

Steel Base Finish	Upholstery Finish
Metal Finishes Chrome Finish C600 Chrome	Fabric Leather

Notes If Chrome finish is specified, add 68.



EAA7095

Price

COM	COL	Gr.1	Gr.2	Gr.3	Gr.4	Gr.5	Gr.6	Gr.7	Gr.8	Gr.9	Gr.10
1761	1947	1872	1983	2095	2206	2317	2428	2539	2650	2762	2873

Leather
LC
4096

EAA909R arca lounge high backrest, wooden rocking base
 EAA909S arca lounge high backrest, wooden sled base

Product Options

Finish	Upholstery Finish
Natural Ashwood	Fabric Leather



EAA909R

Price

COM	COL	Gr.1	Gr.2	Gr.3	Gr.4	Gr.5	Gr.6	Gr.7	Gr.8	Gr.9	Gr.10
2941	3127	3053	3164	3275	3386	3497	3608	3720	3831	3942	4053

Leather
LC
5276



EAA909S

COM	COL	Gr.1	Gr.2	Gr.3	Gr.4	Gr.5	Gr.6	Gr.7	Gr.8	Gr.9	Gr.10
3055	3241	3166	3277	3388	3499	3611	3722	3833	3944	4055	4166

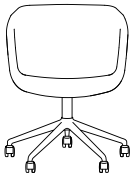
Leather
LC
5389

EAA409C arca 5 spoke aluminium swivel base on casters mini

Product Options

Gas Lift	Aluminium Base	Upholstery Finish
Y Yes	BL Black	Fabric
No No	WH White	Leather

Notes If Gas Lift, Yes (Y) is specified, add 69.
Gas lift (available only in black).

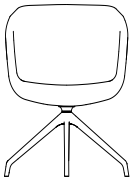


		Price											
		COM	COL	Gr.1	Gr.2	Gr.3	Gr.4	Gr.5	Gr.6	Gr.7	Gr.8	Gr.9	Gr.10
EAA409CN		1172	1358	1283	1394	1506	1617	1728	1839	1950	2061	2173	2284
	Leather												
	LC												
	3507												

EAA4098 arca 4 spoke aluminium swivel base mini

Product Options

Aluminium Base	Upholstery Finish
BL Black	Fabric
WH White	Leather



EAA4098

Price

COM	COL	Gr.1	Gr.2	Gr.3	Gr.4	Gr.5	Gr.6	Gr.7	Gr.8	Gr.9	Gr.10
1289	1475	1401	1512	1623	1734	1845	1956	2068	2179	2290	2401

Leather
LC
3624

EAA5095 arca steel sled base small

Product Options

Steel Base Finish	Upholstery Finish
Metal Finishes	Fabric
Chrome Finish C600 Chrome	Leather

Notes If Chrome finish is specified, add 68.



EAA5095

Price

COM	COL	Gr.1	Gr.2	Gr.3	Gr.4	Gr.5	Gr.6	Gr.7	Gr.8	Gr.9	Gr.10
1442	1628	1553	1664	1776	1887	1998	2109	2220	2332	2443	2554

Leather
LC
3777

EAA8099 arca lounge mid-backrest, swivel wooden base

Product Options

Finish	Upholstery Finish
Natural Ashwood	Fabric Leather



EAA8099

Price

COM	COL	Gr.1	Gr.2	Gr.3	Gr.4	Gr.5	Gr.6	Gr.7	Gr.8	Gr.9	Gr.10
2396	2582	2507	2618	2729	2841	2952	3063	3174	3285	3396	3508

Leather
LC
4731

hive by true design

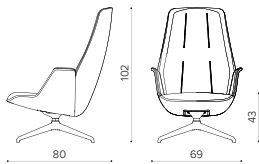
features

10 years after its debut in the market as an executive office chair and waiting armchair, Hive has been revisited and redesigned to adapt to the new needs of the lounge, waiting and hospitality segment. The new polyurethane shell is available in chair and armchair version with double backrest height. The design is characterized by the pronounced lines of the compact armrest and the stitching that shapes the backrest in a vertical direction. It is available with a solid wood 4 legs base or with a 4-spoke steel swivel base.

dimension

EHV9098

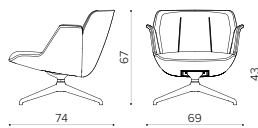
high back lounge armchair, 4-spoke aluminum swivel base



m 1,95 mq 3,15 kg 18 mc 0,56

EHV7098

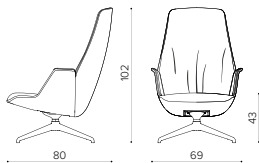
low back lounge armchair, 4-spoke aluminum swivel base



m 1,8 mq 2,5 ka 14 mc 0,38

EHS9098

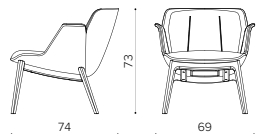
high back lounge armchair, 4-spoke aluminum swivel base



m 2,1 mq 3,15 kg 18 mc 0,56

EHV7094

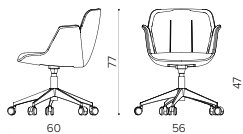
low backrest, 4-wooden legs



m 1,8 mq 2,5 kg 14 mc 0,37

EHV409C

5-spoke aluminum swivel base on casters



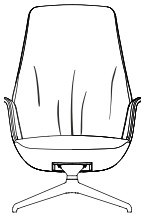
m 1,3 mq 1,7 kg 13 mc 0,33

EHS9098 hive high back lounge soft armchair, 4 spoke aluminium swivel base

Product Options

Tilting Mechanism	Aluminium Finishes	Upholstery Finish
Y Yes	BL Black	Fabric
N No	WH White	Leather

Notes If Gas Lift, Yes (Y) is specified, add 113.



EHS9098N

Price

COM	COL	Gr.1	Gr.2	Gr.3	Gr.4	Gr.5	Gr.6	Gr.7	Gr.8	Gr.9	Gr.10
2027	2213	2138	2249	2361	2472	2583	2694	2805	2916	3028	3139

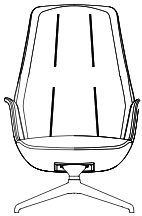
Leather
LC
4362

EHV9098 hive high back lounge armchair, 4 spoke aluminium swivel base

Product Options

Tilting Mechanism	Aluminium Finishes	Upholstery Finish
Y Yes	BL Black	Fabric
No No	WH White	Leather

Notes If Gas Lift, Yes (Y) is specified, add 113.



EHS9098N

Price

COM	COL	Gr.1	Gr.2	Gr.3	Gr.4	Gr.5	Gr.6	Gr.7	Gr.8	Gr.9	Gr.10
2027	2213	2138	2249	2361	2472	2583	2694	2805	2916	3028	3139

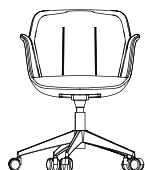
Leather
LC
4362

EHV409C hive 5-spoke aluminium swivel base on casters mini

Product Options

Gas Lift	Tilting Mechanism	Aluminium Finishes	Upholstery Finish
Y Yes	Y Yes	BL Black	Fabric
No No	No No	WH White	Leather

Notes If Gas Lift, Yes (Y) is specified, add 69.
If Tilting Mechanism, Yes (Y) is specified, add 113.



EHV409CNN

Price

COM	COL	Gr.1	Gr.2	Gr.3	Gr.4	Gr.5	Gr.6	Gr.7	Gr.8	Gr.9	Gr.10
1396	1582	1508	1619	1730	1841	1952	2063	2175	2286	2397	2508

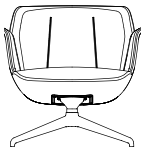
Leather
LC
3731

EHV7098 hive low back lounge armchair, 4 spoke aluminium swivel base

Product Options

Tilting Mechanism	Aluminium Finishes	Upholstery Finish
Y Yes	BL Black	Fabric
No No	WH White	Leather

Notes If Gas Lift, Yes (Y) is specified, add 113.



EHV7098N

Price

COM	COL	Gr.1	Gr.2	Gr.3	Gr.4	Gr.5	Gr.6	Gr.7	Gr.8	Gr.9	Gr.10
1708	1894	1819	1930	2042	2153	2264	2375	2486	2598	2709	2820

Leather
LC
4043

EHV7094 hive lounge low backrest, 4-wooden legs

Product Options

Base Finish	Upholstery Finish
Natural Ashwood	Fabric Leather



EHV7094

Price

COM	COL	Gr.1	Gr.2	Gr.3	Gr.4	Gr.5	Gr.6	Gr.7	Gr.8	Gr.9	Gr.10
2099	2285	2210	2321	2432	2543	2655	2766	2877	2988	3099	3211

Leather
LC
4433

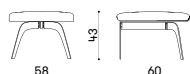
millepiedi by true design

features

Millepiedi is characterized by a modern and minimal design and develops a concept of functionality and flexibility in a wide range of configurations and dimensions. The contemporary design develops in a wide range of configurations and dimensions a conceptual idea based on functionality and flexibility, combined with high end details. The importance of the quality is translated into a vibrant union of design and craftsmanship experience, enhanced by a constant research in details and finishings.

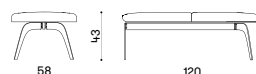
dimension

EMP1L00
side 1 seater module



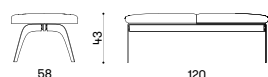
m 0,7 ☆ mq 1,4 📦 kg 10 📏 mc 0,15

EMP2L00
side 2 seater bench



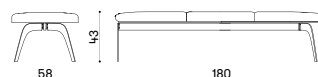
m 1,4k ☆ mq 2,7 📦 g 20 📏 mc 0,3

EMP2C00
central 2 seater bench



m 1,4 ☆ mq 2,7 📦 kg 20 📏 mc 0,

EMP3L00
side 3 seater bench



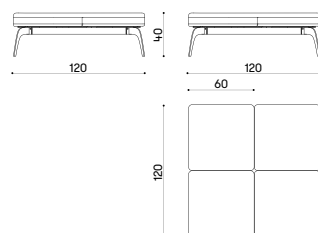
m 1,6 ☆ mq 2,8 📦 kg 30 📏 mc 0,45

EMP3C00



m 1,6 ☆ mq 2,8 📦 kg 30 📏 mc 0,45

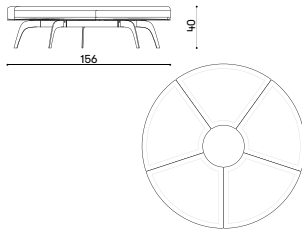
EMP5POS
square low bench



m 4,5 ☆ mq 8 📦 kg 65 📏 mc 0,57

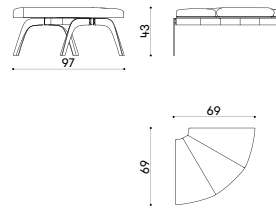
dimension

EMP5P0R
circular low bench



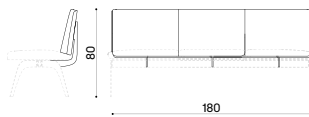
m 5 □ mq 8,5 ⚖ kg 75 📏 mc 1,5

EMPA000
corner element



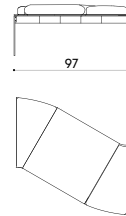
m 1,5 □ mq 2,9 ⚖ kg 15 📏 mc 0,2

EMP330W
3 seater backrest module



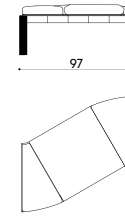
m 1,8 □ mq 3 ⚖ kg 15 📏 mc 0,2

EMPSR00
right "S" element

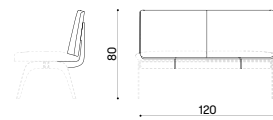


m 1,5 □ mq 2,9 ⚖ kg 15 📏 mc 0,15

EMPSL00
left "S" element

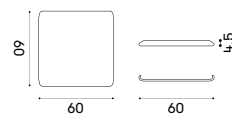


EMP220W
2 seater backrest module



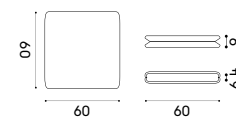
m 1,6 □ mq 2,7 ⚖ kg 10 📏 mc 0,15

EMPTR01
single central table



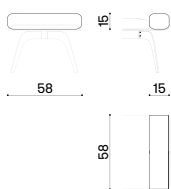
⚖ kg 1,0m 📏 c 0,015

EMPTR02
double central table



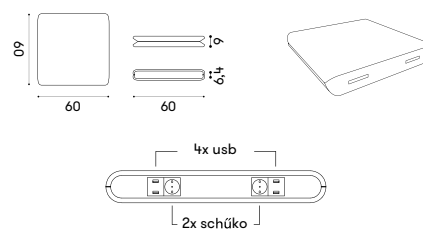
⚖ kg 2,0m 📏 c 0,03

EPBBOO
armrest



m 0,3 □ mq 0,55 ⚖ kg 0,5m 📏 c 0,05

EMPTRE2
double central table with power supply

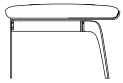


⚖ kg 2,0m 📏 c 0,03

EMP1L00 millepedi side 1 seater module

Product Options

Wooden Base Finishes	Upholstery Finish
NK Oak Wood	Fabric Leather



EMP1L00

Price

COM	COL	Gr.1	Gr.2	Gr.3	Gr.4	Gr.5	Gr.6	Gr.7	Gr.8	Gr.9	Gr.10
1833	1937	1885	1916	1947	1978	2009	2041	2072	2103	2134	2165

Leather
LC
2508

EMP2C00 millepiedi central 2 seater bench
EMP3C00 millepiedi central 3 seater bench

Product Options

Wooden Base Finishes	Upholstery Finish
NK Oak Wood	Fabric Leather



EMP2C00

Price

COM	COL	Gr.1	Gr.2	Gr.3	Gr.4	Gr.5	Gr.6	Gr.7	Gr.8	Gr.9	Gr.10
2418	2604	2522	2574	2626	2678	2729	2781	2833	2885	2937	2989

Leather
LC
3561



EMP3C00

COM	COL	Gr.1	Gr.2	Gr.3	Gr.4	Gr.5	Gr.6	Gr.7	Gr.8	Gr.9	Gr.10
2961	3147	3065	3117	3169	3221	3273	3325	3377	3429	3481	3533

Leather
LC
4104

EMP2L00 millepiedi side 2 seater bench
EMP3L00 millepiedi side 3 seater bench

Product Options

Wooden Base Finishes	Upholstery Finish
NK Oak Wood	Fabric Leather

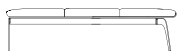


EMP2L00

Price

COM	COL	Gr.1	Gr.2	Gr.3	Gr.4	Gr.5	Gr.6	Gr.7	Gr.8	Gr.9	Gr.10
2521	2707	2625	2676	2728	2780	2832	2884	2936	2988	3040	3092

Leather
LC
3664



EMP3L00

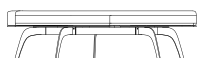
COM	COL	Gr.1	Gr.2	Gr.3	Gr.4	Gr.5	Gr.6	Gr.7	Gr.8	Gr.9	Gr.10
3061	3247	3165	3217	3269	3321	3373	3425	3476	3528	3580	3632

Leather
LC
4204

EMP5P0R millepiedi circular low bench
EMP5P0S millepiedi square low bench

Product Options

Wooden Base Finishes	Upholstery Finish
NK Oak Wood	Fabric Leather



EMP5P0R

Price

COM	COL	Gr.1	Gr.2	Gr.3	Gr.4	Gr.5	Gr.6	Gr.7	Gr.8	Gr.9	Gr.10
7176	7384	7447	7540	7634	7727	7821	7914	8008	8101	8195	8288

Leather

LC
9317



EMP5P0S

COM	COL	Gr.1	Gr.2	Gr.3	Gr.4	Gr.5	Gr.6	Gr.7	Gr.8	Gr.9	Gr.10
7017	7225	7267	7350	7433	7516	7599	7682	7765	7849	7932	8015

Leather

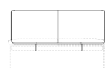
LC
8929

EMP220W millepiedi 2 seater backrest module
EMP330W millepiedi 3 seater backrest module

Product Options

Wooden Base Finishes	Upholstery Finish
NK Oak Wood	Fabric Leather

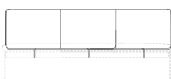
Price



EMP220W

COM	COL	Gr.1	Gr.2	Gr.3	Gr.4	Gr.5	Gr.6	Gr.7	Gr.8	Gr.9	Gr.10
2184	2370	2288	2340	2392	2444	2496	2548	2600	2652	2703	2755

Leather
LC
3327



EMP330W

COM	COL	Gr.1	Gr.2	Gr.3	Gr.4	Gr.5	Gr.6	Gr.7	Gr.8	Gr.9	Gr.10
2732	2918	2835	2887	2939	2991	3043	3095	3147	3199	3251	3303

Leather
LC
3874

EMP2000 millepiedi 2 seater bench
EMP3000 millepiedi 3 seater bench

Product Options

Wooden Base Finishes	Upholstery Finish
NK Oak Wood	Fabric Leather



EMP2000

Price

COM	COL	Gr.1	Gr.2	Gr.3	Gr.4	Gr.5	Gr.6	Gr.7	Gr.8	Gr.9	Gr.10
2618	2701	2701	2733	2764	2795	2826	2857	2888	2920	2951	2982

Leather
LC
3325



EMP3000

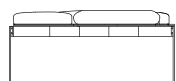
COM	COL	Gr.1	Gr.2	Gr.3	Gr.4	Gr.5	Gr.6	Gr.7	Gr.8	Gr.9	Gr.10
3096	3282	3200	3252	3304	3356	3408	3460	3512	3564	3616	3668

Leather
LC
4239

EMPA000 millepiedi 2 corner elements

Product Options

Wooden Base Finishes	Upholstery Finish
NK Oak Wood	Fabric Leather



EMPA000

Price

COM	COL	Gr.1	Gr.2	Gr.3	Gr.4	Gr.5	Gr.6	Gr.7	Gr.8	Gr.9	Gr.10
2045	2138	2138	2180	2221	2263	2305	2346	2388	2429	2471	2512

Leather
LC
2969

EMPBB00 millepiedi 2 armrest

Product Options

Upholstery Finish

Fabric
Leather



EMPBB00

Price

COM	COL	Gr.1	Gr.2	Gr.3	Gr.4	Gr.5	Gr.6	Gr.7	Gr.8	Gr.9	Gr.10
258	289	289	299	310	320	330	341	351	362	372	382

Leather
LC
497

EMPSL00 millepiedi left “S” element
EMPSR00 millepiedi right “S” element

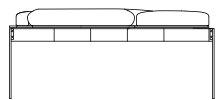
Product Options

Wooden Base Finishes	Upholstery Finish
NK Oak Wood	Fabric Leather

Price

EMPSL00

COM	COL	Gr.1	Gr.2	Gr.3	Gr.4	Gr.5	Gr.6	Gr.7	Gr.8	Gr.9	Gr.10
2614	2800	2718	2770	2822	2874	2926	2978	3030	3082	3134	3186



EMPSR00

Leather
LC
3757

COM	COL	Gr.1	Gr.2	Gr.3	Gr.4	Gr.5	Gr.6	Gr.7	Gr.8	Gr.9	Gr.10
2614	2800	2718	2770	2822	2874	2926	2978	3030	3082	3134	3186

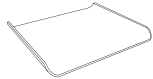
Leather
LC
3757

- EMPTR01 **millepiedi** single central table
- EMPTR02 **millepiedi** double central table
- EMPTRE2 **millepiedi** double central table with power supply

Product Options

Worksurface Finishes

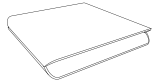
NK Oak Wood
 White Lacquered MDF



EMPTR01

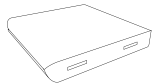
Price

White Lacquered	Oak Wood
766	819



EMPTR02

White Lacquered	Oak Wood
1470	1584



EMPTRE2

White Lacquered	Oak Wood
2235	2348

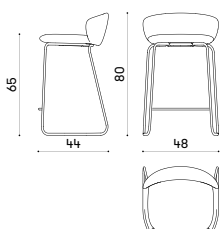
not by true design

features

A wide shell embraces the seat in a warm embrace. The seams define the soft lines, giving it an elegant and versatile look. Suitable for conference hall and relax spaces of hotel and domestic environment. The NOT family, characterized by a wide seat shell and an elegant shape, introduces 2 new versions: the Lounge, wider and more comfortable, and the Mini, providing a more compact shell and new bases to open the use of this products to new environments.

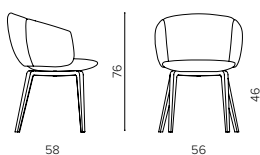
dimension

ENT65U05
stackable stool with steel sled base



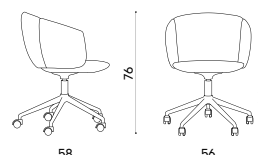
m 0,75 ⦿ mq 1,5 ⚖ kg 7,5m 📦 c 0,16

ENT4094
4 legs wooden base



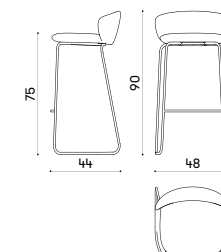
m 1,4 ⦿ mq 2,7 ⚖ kg 7m 📦 c 0,24

ENT409C
5-spoke aluminum swivel base on casters



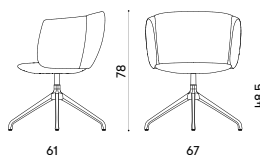
m 1,4 ⦿ mq 2,7 ⚖ kg 7m 📦 c 0,24

ENT75U05
stackable stool with steel sled base



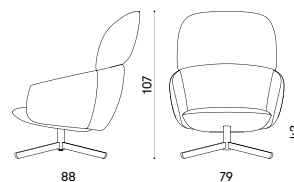
m 0,75 ⦿ mq 1,5 ⚖ kg 7,5m 📦 c 0,19

ENT5098
4-spoke aluminum swivel base



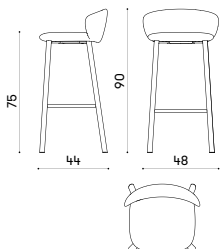
m 1,5 ⦿ mq 3 ⚖ kg 8 📦 mc 0,3

ENT8090
high back lounge armchair, steel base



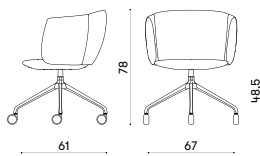
m 3,5m ⦿ mq 6,3 ⚖ kg 27 📦 c 0,7

ENT75U09
stool with 4 wooden legs



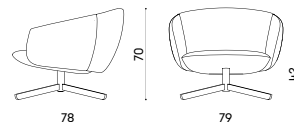
m 0,75 ⦿ mq 1,5 ⚖ kg 7,5m 📦 c 0,19

ENT5098R
4-spoke aluminum swivel base on casters



m 1,5 ⦿ mq 3 ⚖ kg 9 📦 mc 0,3

ENT7090
low back lounge armchair, steel base



m 2,52 ⦿ mq 4,5 ⚖ kg 25 📦 mc 0,4

ENT65U05 not stackable stool with steel sled base stool
ENT75U05 not stackable stool with steel sled base

Product Options

Steel Base Finishes	Upholstery Finish
Metal Finishes	Fabric Leather



Price

	COM	COL	Gr.1	Gr.2	Gr.3	Gr.4	Gr.5	Gr.6	Gr.7	Gr.8	Gr.9	Gr.10
ENT65U05	944	1152	996	1028	1059	1090	1121	1152	1183	1215	1246	1277

Leather Leather Leather
 LC
 1620

	COM	COL	Gr.1	Gr.2	Gr.3	Gr.4	Gr.5	Gr.6	Gr.7	Gr.8	Gr.9	Gr.10
ENT75U05	966	1174	1018	1049	1081	1112	1143	1174	1205	1236	1268	1299

Leather
 LC
 1642

ENT75U09 not stool with 4 wooden legs

Product Options

Wooden Base Finishes	Upholstery Finish
Natural Ashwood	Fabric Leather

Notes Custom colour frame <10pcs - add 68, if >10pcs is free



Price

	COM	COL	Gr.1	Gr.2	Gr.3	Gr.4	Gr.5	Gr.6	Gr.7	Gr.8	Gr.9	Gr.10
ENT75U09	1757	1965	1809	1840	1871	1902	1934	1965	1996	2027	2058	2089
Leather LC												
	2432											

ENT4094 not 4 legs wooden base mini

Product Options

Wooden Base Finishes	Upholstery Finish
NH Natural AshWood	Fabric Leather



ENT4094

Price

COM	COL	Gr.1	Gr.2	Gr.3	Gr.4	Gr.5	Gr.6	Gr.7	Gr.8	Gr.9	Gr.10
1342	1550	1436	1467	1498	1529	1561	1592	1623	1654	1685	1716

Leather
LC
2059

ENT5098 not 4 spoke aluminium swivel base small

Product Options

Aluminium Finishes	Upholstery Finish
BL Black	Fabric
WH White	Leather



ENT5098

Price

COM	COL	Gr.1	Gr.2	Gr.3	Gr.4	Gr.5	Gr.6	Gr.7	Gr.8	Gr.9	Gr.10
1567	1775	1660	1691	1723	1754	1785	1816	1847	1879	1910	1941

Leather

LC
2284

ENT5098R not 4 spoke aluminium swivel base on casters small

Product Options

Aluminium Finishes	Upholstery Finish
BL Black	Fabric
WH White	Leather



ENT5098R

Price

COM	COL	Gr.1	Gr.2	Gr.3	Gr.4	Gr.5	Gr.6	Gr.7	Gr.8	Gr.9	Gr.10
1630	1838	1724	1755	1786	1817	1848	1880	1911	1942	1973	2004

Leather

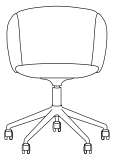
LC
2347

ENT409C not 5 spoke aluminium swivel base on casters mini

Product Options

Gas Lift	Aluminium Finishes	Upholstery Finish
Y Yes	BL Black	Fabric
No No	WH White	Leather

Notes If Gas Lift, Yes (Y) is specified, add 69.



ENT409C

Price

COM	COL	Gr.1	Gr.2	Gr.3	Gr.4	Gr.5	Gr.6	Gr.7	Gr.8	Gr.9	Gr.10
1373	1580	1466	1497	1528	1560	1591	1622	1653	1684	1715	1747

Leather
LC
2089

ENT7090 not low back lounge armchair, steel base

Product Options

Tilting Mechanism	Steel Base Finishes	Upholstery Finish
Y Yes	Metal Finishes	Fabric
N No		Leather

Notes If Tilting mechanism, Yes (Y) is specified, add 114.

Price

ENT7090

COM	COL	Gr.1	Gr.2	Gr.3	Gr.4	Gr.5	Gr.6	Gr.7	Gr.8	Gr.9	Gr.10
2404	2612	2550	2602	2654	2706	2758	2809	2861	2913	2965	3017

Leather

LC
3589

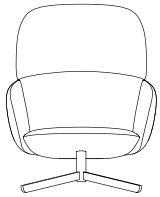


ENT8090 not high back lounge armchair, steel base

Product Options

Tilting Mechanism	Steel Base Finishes	Upholstery Finish
Y Yes	Metal Finishes	Fabric
No No		Leather

Notes If Tilting mechanism, Yes (Y) is specified, add 114.



ENT8090

Price

COM	COL	Gr.1	Gr.2	Gr.3	Gr.4	Gr.5	Gr.6	Gr.7	Gr.8	Gr.9	Gr.10
3009	3217	3206	3258	3310	3362	3414	3466	3518	3570	3622	3674

Leather
LC
4245

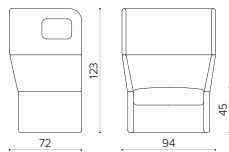
oracle by true design

features

Oracle is a tactile modular meeting solution for open-plan spaces. The ‘room within a room’ booth provides an informal semi-private comfortable meeting space for activity based workers. With its versatile configurations it can be used as a quiet harbor to get away from your desk, or as a meeting/collaboration space for 2-6 occupants. The high back design creates the sense of a mini-environment acting as a divider from the outside world, we have also added a porthole vision feature that enables you to discreetly see if the booth/pod is occupied. Also included within the range are a number of work surfaces/desk tops (along with provision for power) that can be substituted for sofa elements to provide hot desking or touchdown spaces for transient workers.

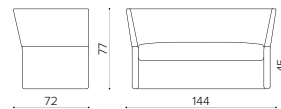
dimension

EOR100H
high back armchair



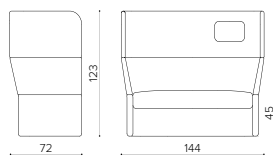
m 5,2k □ mq 9,1 🛒 g 35 🛠 mc 0,85

EOR2000
2 seater sofa



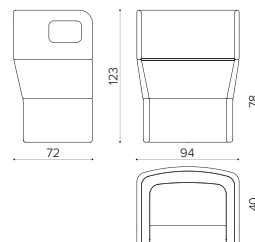
m 5k □ mq 9 🛒 g 35 🛠 mc 0,8

EOR200H
2-seater high back sofa



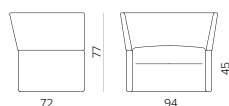
m 7k □ mq 12 🛒 g 50 🛠 mc 1,2

EORD10H
1 seater desk



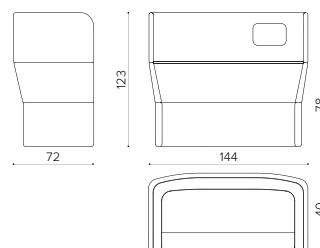
m 4,5k □ mq 7,9 🛒 g 50 🛠 mc 1

EOR1000
armchair



m 3,75 □ mq 6,75 🛒 kg 25m 🛠 c 0,6

EORD20H
2 seater desk

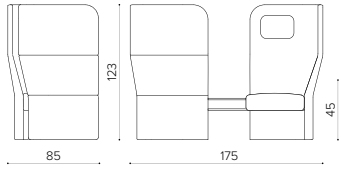


m 6k □ mq 10,2 🛒 g 60 🛠 mc 1,4

dimension

EORFF0H

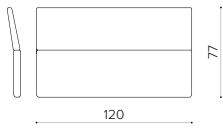
face to face sofa with table



m 8k □ mq 14 △ g 65 ✚ mc 1,5

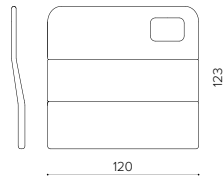
EORP000

low connection panel



EORP00H

high connection panel



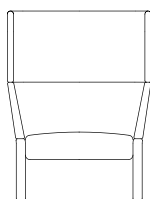
EOR100H oracle high back armchair
EOR200H oracle 2 seater high back sofa

Product Options

Upholstery Finish

Fabric

Leather



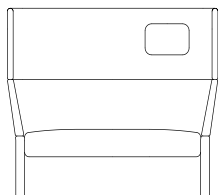
EOR100H

Price

COM	COL	Gr.1	Gr.2	Gr.3	Gr.4	Gr.5	Gr.6	Gr.7	Gr.8	Gr.9	Gr.10
3844	4052	4125	4218	4312	4405	4499	4592	4686	4779	4873	4966

Leather Leather

LC	LD
5995	6089



EOR200H

COM	COL	Gr.1	Gr.2	Gr.3	Gr.4	Gr.5	Gr.6	Gr.7	Gr.8	Gr.9	Gr.10
4715	4923	5089	5193	5297	5401	5505	5609	5712	5816	5920	6024

Leather Leather

LC	LD
7167	7271

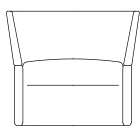
EOR1000 oracle armchair
EOR2000 oracle 2 seater sofa

Product Options

Upholstery Finish

Fabric

Leather



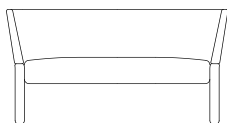
EOR1000

Price

COM	COL	Gr.1	Gr.2	Gr.3	Gr.4	Gr.5	Gr.6	Gr.7	Gr.8	Gr.9	Gr.10
2511	2719	2719	2781	2844	2906	2968	3031	3093	3155	3218	3280

Leather Leather

LC	LD
3966	4028



EOR2000

COM	COL	Gr.1	Gr.2	Gr.3	Gr.4	Gr.5	Gr.6	Gr.7	Gr.8	Gr.9	Gr.10
3183	3391	3454	3537	3620	3703	3786	3869	3952	4035	4119	4202

Leather Leather

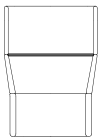
LC	LD
5116	5199

EORD10H oracle 1 seater desk
EORD20H oracle 2 seater desk

Product Options

Upholstery Finish

Fabric
 Leather



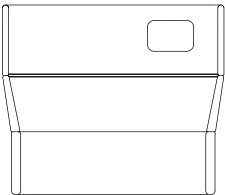
EORD10H

Price

COM	COL	Gr.1	Gr.2	Gr.3	Gr.4	Gr.5	Gr.6	Gr.7	Gr.8	Gr.9	Gr.10
3582	3790	3790	3853	3915	3977	4040	4102	4164	4227	4289	4351

Leather Leather

LC	LD
5037	5099



EORD20H

COM	COL	Gr.1	Gr.2	Gr.3	Gr.4	Gr.5	Gr.6	Gr.7	Gr.8	Gr.9	Gr.10
4512	4720	4720	4783	4845	4907	4970	5032	5094	5157	5219	5281

Leather Leather

LC	LD
5967	6029

EORP000 oracle low connection panel
EORP00H oracle high connection panel
EORFF0H oracle face to face sofa with table

Product Options

Upholstery Finish

Fabric
 Leather

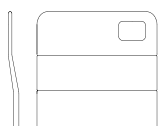


EORP000

Price

COM	COL	Gr.1	Gr.2	Gr.3	Gr.4	Gr.5	Gr.6	Gr.7	Gr.8	Gr.9	Gr.10
1680	1888	1846	1898	1950	2002	2054	2106	2158	2210	2262	2314

Leather LC	Leather LD
2885	2937

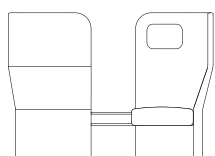


EORP00H

COM	COL	Gr.1	Gr.2	Gr.3	Gr.4	Gr.5	Gr.6	Gr.7	Gr.8	Gr.9	Gr.10
2414	2621	2632	2705	2777	2850	2923	2995	3068	3141	3214	3286

Leather LC	Leather LD
4086	4159

EORFF0H



COM	COL	Gr.1	Gr.2	Gr.3	Gr.4	Gr.5	Gr.6	Gr.7	Gr.8	Gr.9	Gr.10
6886	7094	7167	7229	7292	7354	7416	7479	7541	7603	7666	7728

Leather LC	Leather LD
8414	8476

tables

tables

Beso	151	Rec	199
Clarion	156	Wing	217
Mare	166	Confair	235
Pala	168	Timetable	242
Dock	171		
Boom	177		
Easy Boy	180		
Hotel	182		
Samu	186		

artifort

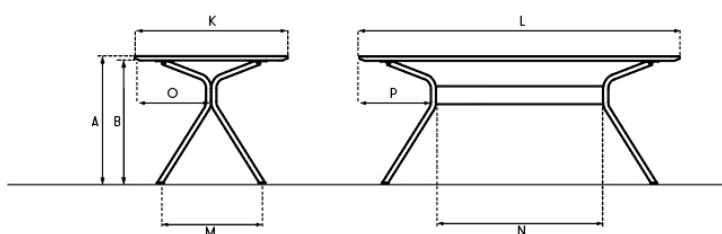
beso by artifort

features

The Beso Table collection matches the Beso chair programme, consisting of a series of tables with rectangular or round tops with an elegant and sculptural base.

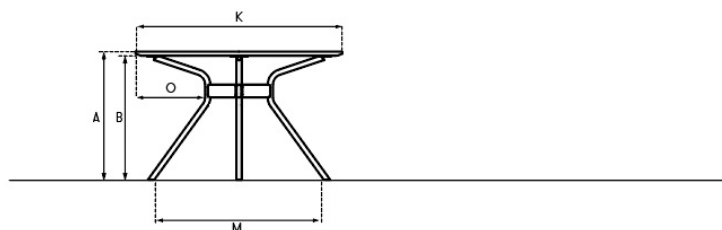
Clever positioning of the four table legs Clever positioning of the four table legs mean users have considerable freedom of movement, creating extra chair space along the long side or at the head of the table. The construction beam matches the table top or the colour of the base and provides the accent and character of the design. The metal legs swing open to the left and right of the beam, so the construction supports the table well.

dimension



Beso Table rectangle

kern	A	B	K	L	M	N	O	P
25mm	75cm	72,5cm	90cm	180cm	56cm	120cm	43cm	27cm
25mm	75cm	72,5cm	90cm	200cm	56cm	120cm	43cm	37cm
25mm	75cm	72,5cm	90cm	220cm	56cm	120cm	43cm	47cm



Beso Table round

kern	A	B	K	O	M
25mm	75cm	72,5cm	120cm	46cm	98cm
25mm	75cm	72,5cm	130cm	51cm	98cm
25mm	75cm	72,5cm	140cm	56cm	98cm

EARBSTC beso round table height 75cm

Product Options

Tabletop Diameter		Tabletop Finishes	
12	120cm	A	2.4cm Plywood, Laminate Arpa Fenix, Chamfered Edge
13	130cm	B	2.4cm Plywood, Veneer, Chamfered Edge
14	140cm	C	2.5cm Solid Oak, Oil or Satin, Chamfered Edge
		D	1.2cm Compact, Arpa Fenix, Double Chamfered Edge

Notes

Tabletop

(A) Material: 2.4cm plywood

Top Coat: Laminate Arpa Fenix

Finishing Edge: Chamfered Edge

(B) Material: 2.4cm plywood

Top Coat: Oak Veneer with standard oil finish

Finishing Edge: Chamfered Edge

(C) Material: 2.5cm solid oak

Top Coat: Transparent lacquered (B20) or black stained (B11) or in a standard oil finish

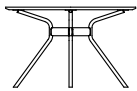
Finishing Edge: Chamfered milled, finished as top coat

(D) Material: 1.2cm compact

Top Coat: Arpa Fenix

Finishing Edge: Double Chamfered

Price



EARBSTC12
EARBSTC13
EARBSTC14

Finishes A	Finishes B	Finishes C	Finishes D
5318	5318	8450	10530
5550	5550	8837	10918
5784	5784	9225	11304

EARBSTRT beso rectangle table, two piece table top, height 75cm

Product Options

Depth	Width	Netbox Position	Tabletop Finishes
14 140cm	26 260cm	A 1 × 2 Netbox spots	A 2.4cm Plywood, Laminate Arpa Fenix, Chamfered Edge
16 160cm	30 300cm	B 1 × 4 Netbox spots	B 2.4cm Plywood, Veneer, Chamfered Edge
		C 2 × 2 Netbox spots	
		D 3 × 2 Netbox spots	

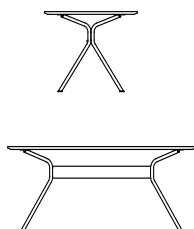
Notes

Tabletop

(A) Material: 2.4cm plywood
 Top Coat: Laminate Arpa Fenix
 Finishing Edge: Chamfered Edge

(B) Material: 2.4cm plywood
 Top Coat: Oak Veneer with standard oil finish
 Finishing Edge: Chamfered Edge

Price



EARBSTRT1426
 EARBSTRT1430
 EARBSTRT1626
 EARBSTRT1630

	Finishes A	Finishes B
EARBSTRT1426	16499	16499
EARBSTRT1430	15277	15277
EARBSTRT1626	15890	15890
EARBSTRT1630	17161	17161

EARBSTRD beso rectangle table, height 75cm, depth 90cm

Product Options

Width	Tabletop Finishes
18 180cm	A 2.4cm Plywood, Laminate Arpa Fenix, Chamfered Edge
20 200cm	B 2.4cm Plywood, Veneer, Chamfered Edge
22 220cm	C 2.5cm Solid Oak, Oil or Satin, Chamfered Edge
	D 1.2cm Compact, Arpa Fenix, Double Chamfered Edge

Notes

Tabletop

(A) Material: 2.4cm plywood

Top Coat: Laminate Arpa Fenix
Finishing Edge: Chamfered Edge

(B) Material: 2.4cm plywood

Top Coat: Oak Veneer with standard oil finish
Finishing Edge: Chamfered Edge

(C) Material: 2.5cm solid oak

Top Coat: Transparent lacquered (B20) or black stained (B11) or in a standard oil finish
Finishing Edge: Chamfered milled, finished as top coat

(D) Material: 1.2cm compact

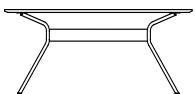
Top Coat: Arpa Fenix
Finishing Edge: Double Chamfered

Price



EARBSTRD18
EARBSTRD20
EARBSTRD22

Finishes A	Finishes B	Finishes C	Finishes D
8303	8303	10903	12566
8569	8569	11193	12856
8833	8833	11490	13155



EARBSTR **beso** rectangle table, height 75cm, depth 110cm

Product Options

Width	Netbox Position	Tabletop Finishes
24 240cm	A 1 × 2 Netbox spots	A 2.4cm Plywood, Laminate Arpa Fenix, Chamfered Edge
26 260cm	B 1 × 4 Netbox spots	B 2.4cm Plywood, Veneer, Chamfered Edge
28 280cm	C 2 × 2 Netbox spots	C 2.5cm Solid Oak, Oil or Satin, Chamfered Edge
30 300cm	D 3 × 2 Netbox spots	

Notes

Tabletop

(A) Material: 2.4cm plywood

Top Coat: Laminate Arpa Fenix

Finishing Edge: Chamfered Edge

(B) Material: 2.4cm plywood

Top Coat: Oak Veneer with standard oil finish

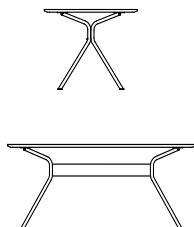
Finishing Edge: Chamfered Edge

(C) Material: 2.5cm solid oak

Top Coat: Transparent lacquered (B20) or black stained (B11) or in a standard oil finish

Finishing Edge: Chamfered milled, finished as top coat

Price



EARBSTR24
EARBSTR26
EARBSTR28
EARBSTR30

Finishes A	Finishes B	Finishes C
10142	10142	11619
10604	10604	12018
11080	11080	12419
11580	11580	12823

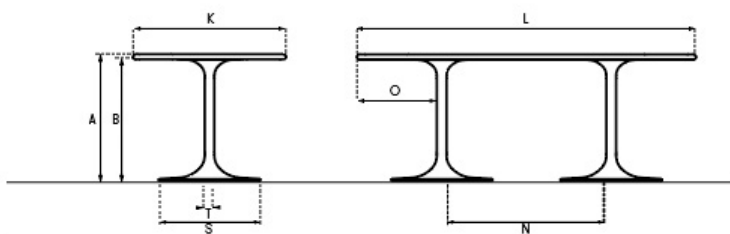
clarion by artifort

features

The Clarion dining table is composed as a medly that creatively combines two archetypal trumpet bases and a steel tube, together capable of supporting a table top. The central position of the round base gives your maximum freedom of movement.

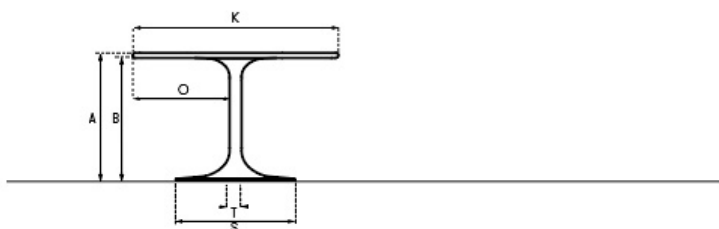
The milled edge table top of Clarion is available in various shapes: round, oval or boat-shaped. The Clarion program is compromised of conference tables, dining tables, bistro tables, counter and bar tables and a series of lower tables. Clarion offers multiple options in size, colour, materials and finishes. Combine Clarion with an elegant chair, an inviting barstool or even with luxurious conference armchairs.

dimension



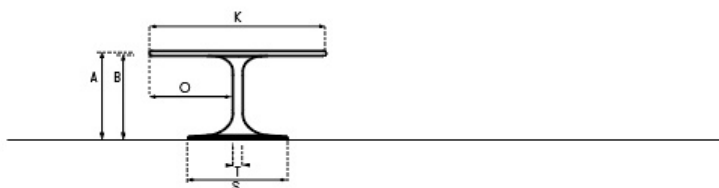
Clarion Medium boat-shaped

kern	A	B	K	L	N	O	S	T
30mm	75cm	72cm	100cm	220cm	104,3cm	52cm	60cm	5,7cm
30mm	75cm	72cm	110cm	240cm	113,0cm	57cm	60cm	5,7cm
30mm	75cm	72cm	110cm	260cm	134cm	57cm	60cm	5,7cm
30mm	75cm	72cm	120cm	280cm	153cm	57cm	70cm	7,0cm
30mm	75cm	72cm	120cm	300cm	153cm	67cm	70cm	7,0cm



Clarion round

core	A	B	K	O	S	T
30mm	75cm	72cm	120cm	57cm	70cm	7cm
30mm	75cm	72cm	140cm	67cm	80cm	7cm
30mm	75cm	72cm	160cm	76cm	80cm	8cm



Clarion Low round

core	A	B	K	O	S	T
30mm	40cm	37cm	50cm	46cm	45cm	4,5cm
30mm	40cm	37cm	80cm	76cm	45cm	4,5cm
30mm	40cm	37cm	100cm	96cm	60cm	4,5cm

EARCLS clarion low side table, round, height 50cm

Product Options

Tabletop Size	Tabletop Finishes
1 Diameter 50cm, Disc Diameter 45cm	A 2.4cm Plywood, Laminate Arpa Fenix, Belly Milled B 2.4cm Plywood, Veneer, Belly Milled C 2.5cm Solid Oak, Oil or Satin, Belly Milled D 1.2cm Compact, Arpa Fenix, Belly Milled

Notes

Tabletop

(A) Material: 2.4cm plywood

Top Coat: Laminate Arpa Fenix

Finishing Edge: Belly Milled

(B) Material: 2.4cm plywood

Top Coat: Oak Veneer with standard oil finish

Finishing Edge: Belly Milled

(C) Material: 2.5cm solid oak

Top Coat: Transparent lacquered (B20) or black stained (B11) or in a standard oil finish

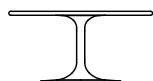
Finishing Edge: Belly Milled

(D) Material: 1.2cm compact

Top Coat: Arpa Fenix

Finishing Edge: Belly Milled

Price



	Finishes A	Finishes B	Finishes C	Finishes D
EARCLS1	3465	3923	4588	5837

EARCLLC clarion low coffee table, round height 40cm

Product Options

Tabletop Size	Tabletop Finishes
1 Diameter 100cm, Disc Diameter 60cm	A 2.4cm Plywood, Laminate Arpa Fenix, Belly Milled
2 Diameter 50cm, Disc Diameter 45cm	B 2.4cm Plywood, Veneer, Belly Milled
3 Diameter 80cm, Disc Diameter 45cm	C 2.5cm Solid Oak, Oil or Satin, Belly Milled
	D 1.2cm Compact, Arpa Fenix, Belly Milled

Notes

Tabletop

(A) Material: 2.4cm plywood

Top Coat: Laminate Arpa Fenix

Finishing Edge: Belly Milled

(B) Material: 2.4cm plywood

Top Coat: Oak Veneer with standard oil finish

Finishing Edge: Belly Milled

(C) Material: 2.5cm solid oak

Top Coat: Transparent lacquered (B20) or black stained (B11) or in a standard oil finish

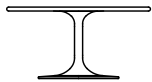
Finishing Edge: Belly Milled

(D) Material: 1.2cm compact

Top Coat: Arpa Fenix

Finishing Edge: Belly Milled

Price



	Finishes A	Finishes B	Finishes C	Finishes D
EARCLLC1	4176	4300	5631	6879
EARCLLC2	3378	3543	4501	5750
EARCLLC3	3822	3897	5062	6310

EARCLMR clarion medium round, height 75cm

Product Options

Tabletop Size		Tabletop Finishes	
1	Diameter 120cm, Disc Diameter 70cm	A	2.4cm Plywood, Laminate Arpa Fenix, Belly Milled
2	Diameter 130cm, Disc Diameter 70cm	B	2.4cm Plywood, Veneer, Belly Milled
3	Diameter 140cm, Disc Diameter 80cm	C	2.5cm Solid Oak, Oil or Satin, Belly Milled
4	Diameter 150cm, Disc Diameter 80cm	D	1.2cm Compact, Arpa Fenix, Belly Milled
5	Diameter 160cm, Disc Diameter 80cm		

Notes Tabletop size (5) are only available if Tabletop Finishes (C) and (D) are selected

Tabletop

(A) Material: 2.4cm plywood

Top Coat: Laminate Arpa Fenix

Finishing Edge: Belly Milled

(B) Material: 2.4cm plywood

Top Coat: Oak Veneer with standard oil finish

Finishing Edge: Belly Milled

(C) Material: 2.5cm solid oak

Top Coat: Transparent lacquered (B20) or black stained (B11) or in a standard oil finish

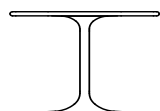
Finishing Edge: Belly Milled

(D) Material: 1.2cm compact

Top Coat: Arpa Fenix

Finishing Edge: Belly Milled

Price



EARCLMR1
EARCLMR2
EARCLMR3
EARCLMR4
EARCLMR5

	Finishes A	Finishes B	Finishes C	Finishes D
EARCLMR1	5477	5477	8559	10639
EARCLMR2	5663	5663	8948	11027
EARCLMR3	5899	5899	9341	11420
EARCLMR4	6077	6077	10465	13377
EARCLMR5	N/A	N/A	11161	14071

EARCLMB clarion medium bistro table, round height 74cm disc

Product Options

Tabletop Size	Tabletop Finishes
1 Diameter 80cm	A 2.4cm Plywood, Laminate Arpa Fenix, Belly Milled
2 Diameter 100cm	B 2.4cm Plywood, Veneer, Belly Milled
	C 2.5cm Solid Oak, Oil or Satin, Belly Milled
	D 1.2cm Compact, Arpa Fenix, Belly Milled

Notes

Tabletop

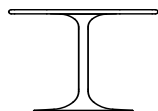
(A) Material: 2.4cm plywood
 Top Coat: Laminate Arpa Fenix
 Finishing Edge: Belly Milled

(B) Material: 2.4cm plywood
 Top Coat: Oak Veneer with standard oil finish
 Finishing Edge: Belly Milled

(C) Material: 2.5cm solid oak
 Top Coat: Transparent lacquered (B20) or black stained (B11) or in a standard oil finish
 Finishing Edge: Belly Milled

(D) Material: 1.2cm compact
 Top Coat: Arpa Fenix
 Finishing Edge: Belly Milled

Price



	Finishes A	Finishes B	Finishes C	Finishes D
EARCLMB1	4277	4353	6016	7264
EARCLMB2	5044	5169	7059	8307

EARCLMO clarion medium oval, height 75cm

Product Options

Tabletop Size		Tabletop Finishes	
1	140×100cm, disc diameter 70cm	A	2.4cm Plywood, Laminate Arpa Fenix, Belly Milled
2	160×120cm, disc diameter 80cm	B	2.4cm Plywood, Veneer, Belly Milled
		C	3.0cm Solid Oak, Oil or Satin, Belly Milled
		D	1.2cm Compact, Arpa Fenix, Belly Milled

Notes

Tabletop

(A) Material: 2.4cm plywood

Top Coat: Laminate Arpa Fenix

Finishing Edge: Belly Milled

(B) Material: 2.4cm plywood

Top Coat: Oak Veneer with standard oil finish

Finishing Edge: Belly Milled

(C) Material: 3.0cm solid oak

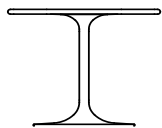
Top Coat: Transparent lacquered (B20) or black stained (B11) or in a standard oil finish

Finishing Edge: Belly Milled

(D) Material: 1.2cm compact

Top Coat: Arpa Fenix

Finishing Edge: Belly Milled



	Price			
	Finishes A	Finishes B	Finishes C	Finishes D
EARCLMO1	7242	6498	8696	10677
EARCLMO2	7466	6697	8969	11741

EARCLBSA clarion medium boat shaped, height 75cm, 2× disc diameter 60cm

Product Options

Tabletop Size		Tabletop Finishes	
1	220 × 100cm	A	2.4cm Plywood, Laminate Arpa Fenix, Belly Milled
2	240 × 110cm	B	2.4cm Plywood, Veneer, Belly Milled
3	260 × 110cm	C	3.0cm Solid Oak, Oil or Satin, Belly Milled

Notes

Tabletop

(A) Material: 2.4cm plywood

Top Coat: Laminate Arpa Fenix

Finishing Edge: Belly Milled

(B) Material: 2.4cm plywood

Top Coat: Oak Veneer with standard oil finish

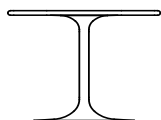
Finishing Edge: Belly Milled

(C) Material: 3.0cm solid oak

Top Coat: Transparent lacquered (B20) or black stained (B11) or in a standard oil finish

Finishing Edge: Belly Milled

Price



EARCLBSA1
EARCLBSA2
EARCLBSA3

Finishes A	Finishes B	Finishes C
10348	9912	11280
10656	10205	11614
10979	10511	11965

EARCLBSB clarion medium oval, height 75cm

Product Options

Tabletop Size		Tabletop Finishes	
1	280 × 120cm	A	2.4cm Plywood, Laminate Arpa Fenix, Belly Milled
2	300 × 120cm	B	2.4cm Plywood, Veneer, Belly Milled

Notes

Tabletop

(A) Material: 2.4cm plywood

Top Coat: Laminate Arpa Fenix

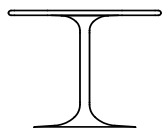
Finishing Edge: Belly Milled

(B) Material: 2.4cm plywood

Top Coat: Oak Veneer with standard oil finish

Finishing Edge: Belly Milled

Price



EARCLBSB1
EARCLBSB2

Finishes A	Finishes B
11415	10929
11756	11252

EARCLHCA clarion high counter table, round height 90cm

Product Options

Tabletop Size	Tabletop Finishes
1 Diameter 100cm, Disc Diameter 70cm	A 2.4cm Plywood, Laminate Arpa Fenix, Belly Milled B 2.4cm Plywood, Veneer, Belly Milled C 3.0cm Solid Oak, Oil or Satin, Belly Milled D 1.2cm Compact, Arpa Fenix, Belly Milled

Notes

Tabletop

(A) Material: 2.4cm plywood

Top Coat: Laminate Arpa Fenix

Finishing Edge: Belly Milled

(B) Material: 2.4cm plywood

Top Coat: Oak Veneer with standard oil finish

Finishing Edge: Belly Milled

(C) Material: 3.0cm solid oak

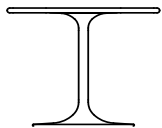
Top Coat: Transparent lacquered (B20) or black stained (B11) or in a standard oil finish

Finishing Edge: Belly Milled

(D) Material: 1.2cm compact

Top Coat: Arpa Fenix

Finishing Edge: Belly Milled



EARCLHCA1

Price

Finishes A	Finishes B	Finishes C	Finishes D
5374	5500	7388	8636

EARCLHB clarion high bar table, round height 110cm

Product Options

Tabletop Size	Tabletop Finishes
1 Diameter 80cm, Disc Diameter 60cm	<p>A 2.4cm Plywood, Laminate Arpa Fenix, Belly Milled</p> <p>B 2.4cm Plywood, Veneer, Belly Milled</p> <p>C 3.0cm Solid Oak, Oil or Satin, Belly Milled</p> <p>D 1.2cm Compact, Arpa Fenix, Belly Milled</p>

Notes

Tabletop

(A) Material: 2.4cm plywood

Top Coat: Laminate Arpa Fenix

Finishing Edge: Belly Milled

(B) Material: 2.4cm plywood

Top Coat: Oak Veneer with standard oil finish

Finishing Edge: Belly Milled

(C) Material: 3.0cm solid oak

Top Coat: Transparent lacquered (B20) or black stained (B11) or in a standard oil finish

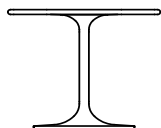
Finishing Edge: Belly Milled

(D) Material: 1.2cm compact

Top Coat: Arpa Fenix

Finishing Edge: Belly Milled

Price



EARCLHB1

Finishes A
4414

Finishes B
4488

Finishes C
6153

Finishes D
8649

mare by artifort**features**

A sleek coffee table for a sleek sofa. The Mare T is developed especially as table to match sofas of the Mare sofa program (Mare loose cushion and Mare fixed cushion). Typical of this design is the slender base, which runs from back to front.

Mare T is available with a square or rectangular table top. The top is veneered or solid oak and the base is made of polished stainless steel or powder coated.

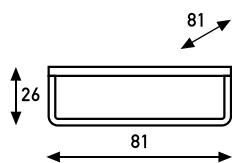
dimension

Table
81 x 81cm

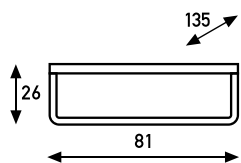


Table
135 x 81cm

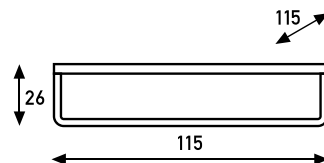


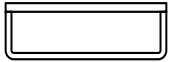
Table
115 x 115cm

EARMARET mare table

Product Options

Table Size	Surface Finish	Base Finish
1 81 × 81cm	Veneer	Stainless Steel
2 115 × 115cm	Solid Oak in Oil Finish	
3 135 × 81cm		

Price



EARMARET1
EARMARET2
EARMARET3

Veneer	Solid Oak In Oil Finish
3917	6009
5719	8976
4816	7607

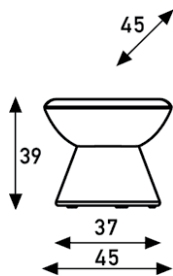
pala by artifort

features

The Pala T side table by designer Luca Nichetto is a modern design that combines well with the Pala armchair and Pala P ottoman. The design combines Artifort's upholstery expertise with a contemporary approach. Characteristic of this series is the fully upholstery of the base with a richness of detail. The decorative stitching follows the flowing lines of the design.

The Pala T side table has a solid oak table top.

dimension



EARPC pala coffee table non swiveling

Product Options

Table Finish

Veneer

Solid Oak in Oil Finish



EARPC

Price

2776

lande

dock by lande

features

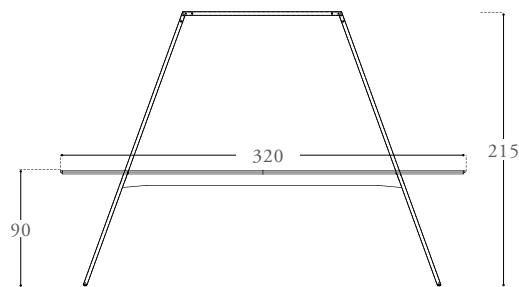
Table with frame and lamps

Dock is a stylish long wooden table with a steel frame that runs above the table. Several lamps can be attached to the frame. The combination of the frame and the lamps above the table creates an intimate atmosphere.

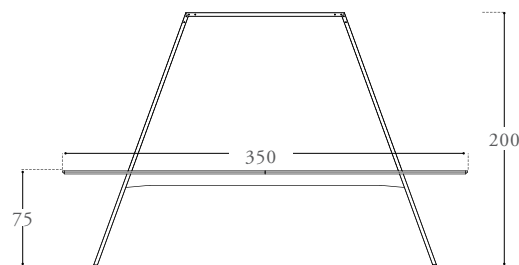
Table with lights

Dock is ideal as a table in a library or landing table in an office. For example in a building where no lamps can be attached to the ceiling. Or high industrial areas where the lighting is not sufficient. The first stylish black Dock tables already shine in the offices of the Port House in Antwerp. "As the name suggests, the table is inspired by a jetty", explains designer Kurt van Overbeke. "Dock is designed for the Antwerp Port House. The company is responsible for mooring boats from all over the world. Mooring is also the function that Dock has within the office. A place where people come to start their workday. The first start-up meeting.

dimension



ELDDK2



ELDDK1

ELDDK1 dock rectangle table, height 75cm

Product Options

Tabletops Size		Neybox Spot		Tabletops Finishes		Base Finishes	
1	320×100cm	1	One Left, One Right	A	24mm plywood, Laminate B, Chamfered Edge	Powder Coated Finishes	
2	320×120cm	2	Two Left, Two Right	B	24mm plywood, Laminate C, Chamfered Edge		
3	320×140cm	3	Three Left, Three Right	C	24mm plywood, Veneer, Chamfered Edge		
4	400×100cm			D	24mm plywood, Veneer F06, Chamfered Edge		
5	400×120cm						
6	400×140cm						

Notes Tabletop Size (1), (2), (4) and (5) are only available if Tabletop Finishes (A), (B) and (C) are selected
 Tabletop Size (3) and (6) are only available if Tabletop Finishes (B) and (D) are selected
 Electrical items must be order together with this dock table
 Failing to do so, will put the table order on hold

Price



ELDDK11
 ELDDK12
 ELDDK13
 ELDDK14
 ELDDK15
 ELDDK16

	Topcoat Laminate B	Topcoat Laminate C	Topcoat Veneer	Topcoat Veneer (F06)
ELDDK11	7697	8586	8586	N/A
ELDDK12	8674	9563	9563	N/A
ELDDK13	N/A	11030	N/A	11030
ELDDK14	9023	10135	10135	N/A
ELDDK15	10147	11253	11253	N/A
ELDDK16	N/A	12547	N/A	12547

ELDDK2 dock rectangle table, height 90cm

Product Options

Tabletops Size		Neybox Spot		Tabletops Finishes		Base Finishes	
1	320×100cm	1	One Left, One Right	A	24mm plywood, Laminate B, Chamfered Edge	Powder Coated Finishes	
2	400×100cm	2	Two Left, Two Right	B	24mm plywood, Laminate C, Chamfered Edge		
		3	Three Left, Three Right	C	24mm plywood, Veneer, Chamfered Edge		

Notes Electrical items must be order together with this dock table. Failing to do so, will put the table order on hold.

Price



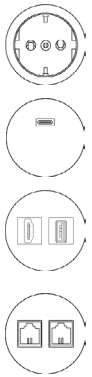
ELDDK21
ELDDK22

	Topcoat Laminate B	Topcoat Laminate C	Topcoat Veneer
ELDDK21	8461	9350	9350
ELDDK22	9786	10899	10899

ELDDK3 dock electrification

Product Options

Netbox Style		Color	
1	Netbox Spot Power 220 Volt GST18, with 40cm Power Cable	B	Black
2	Netbox Spot Power 1× USB-C GST-18 , with 40cm Power Cable	W	White
3	Netbox Spot Data 1× HDMI + 1×USB Data Coupler, with 300cm Power Cable		
4	Netbox Spot Data 2× Ethernet RJJ45 Cat.6 Coupler, Not Included Power Cable		



ELDDK31
ELDDK32
ELDDK33
ELDDK34

Price

267
824
245
202

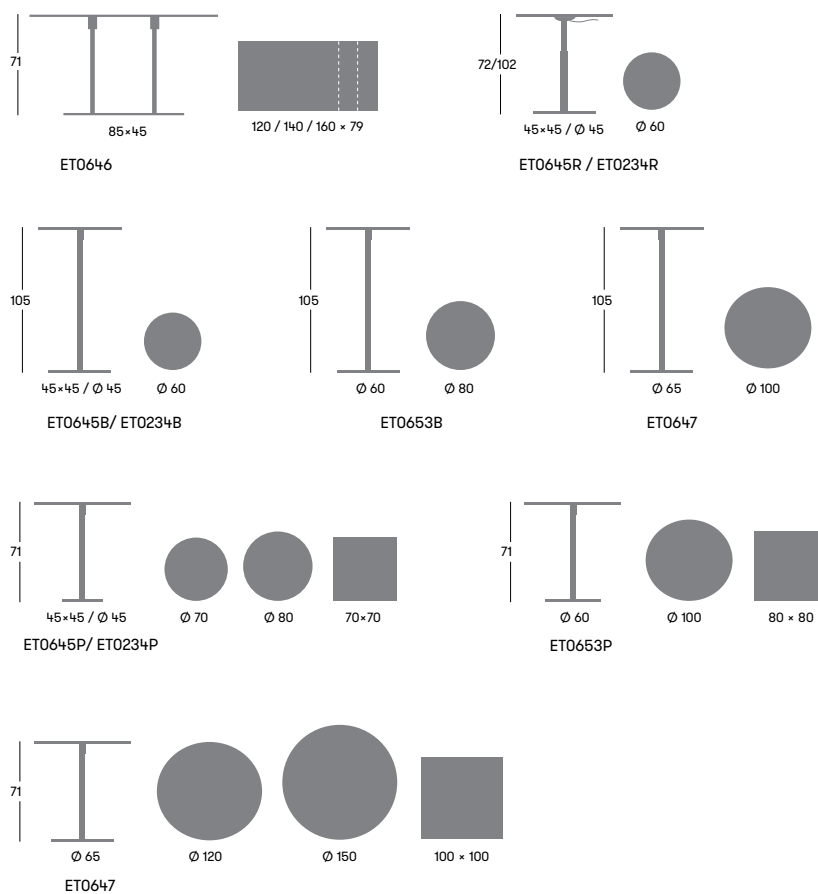
segis

boom by segis

features

Boom Collection brings together in a single series the iconic tables in their round, square and rectangular versions. Base, column and top can be round or square and combine with each other without constraints. Tops are available in various materials and sizes; bases and columns in high-strength steel may be in powder coat, chrome, or brushed stainless. The height can be fixed or adjustable with gas lift. Essential and extremely functional, Boom is perfect for both performing and comfortable spaces.

dimension



ETO boom table base by segis

Product Options

Base Style

645P	45cm Round Base, h.73cm, Column 60mm, Tecnopolymer Fixing Plate
645B	45cm Round Base, h.105cm, Column 60mm, Tecnopolymer Fixing Plate
234P	45×45cm Square Base, h.73cm, Column 60mm, Tecnopolymer Fixing Plate
234B	45×45cm Square Base, h.105cm, Column 60mm, Tecnopolymer Fixing Plate
653P	60cm Round Base, h.73cm, Column 60 mm, Die-cast Fixing Plate
653B	60cm Round Base, h.105cm, Column 60 mm, Die-cast Fixing Plate
647P	65cm Round Base, h.73cm, Column 80 mm, Die-cast Fixing Plate
647B	65cm Round Base, h.105cm, Column 80 mm, Die-cast Fixing Plate
646P	85×45cm Base, h.73cm, Column 60mm, Tecnopolymer Fixing Plates
645D	45cm Round Base, h.40cm, Column 60mm, Tecnopolymer Fixing Plate
645E	45cm Round Base, h.45cm, Column 60mm, Tecnopolymer Fixing Plate
234E	45×45cm Square Base, h.45cm, Column 60mm, Tecnopolymer Fixing Plate
250P	46×46cm Square Base, h.73cm, Square Column 60×60mm, Metal Fixing Plate
250B	46×46cm Square Base, h.110cm, Square Column 60×60mm, Metal Fixing Plate
646B	85×45cm Base, h.105cm, Column 60mm, Tecnopolymer Fixing Plates

Leg Finish

Powder Coated Finishes

Chorme Finish

02 Chromed

Zone Marines

Notes Powder coated finishes and chrome finish are available for all base style are specified.
Chromed are available for all base style except for (250P) and (250B) are specified.
Zone Marines is available only if base style (250P) and (250B) are specified.
Tops not included, order separately.

Price

	Powder Coated Finish	Chrome Finish	Zones Marines
ET0234B	569	692	N/A
ET0234E	517	615	N/A
ET0234P	543	644	N/A
ET0250B	780	N/A	958
ET0250P	714	N/A	832
ET0645B	569	692	N/A
ET0645D	513	613	N/A
ET0645E	517	615	N/A
ET0645P	543	644	N/A
ET0646B	897	1301	N/A
ET0646P	825	1214	N/A
ET0647B	958	1161	N/A
ET0647P	930	1124	N/A
ET0653B	768	936	N/A
ET0653P	742	897	N/A

easy boy by segis

features

Easy Boy is the table for every environment where it is useful to have a stable support. Solid steel frame with a soft shape and dimensions designed specifically to be combined with armchairs and sofas. Available in three heights and in various colours, from the most sedate to the most lively.

dimension



ET004 easy boy table by segis

Product Options

Style	Frame and Top Finish
0 Height 62cm	Powder Coated Finishes
1 Height 53cm	
2 Height 40cm	



ET0040
ET0041
ET0042

Price

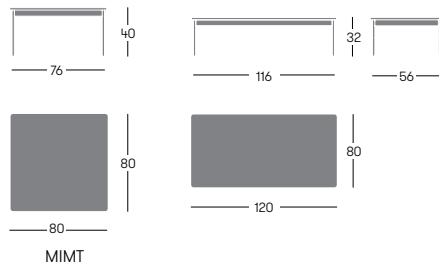
434
434
434

hotel by segis

features

Hotel is a modular seating system characterized by a strong expressive versatility conceived for fluid, linear, and angular combinations. Comfortable pieces designed for enjoyable relaxation and conviviality. The collection includes two and three seater sofas plus an armchair; armrest options include an upholstered armrest in two sizes and a tablet arm for computer or other support. Joining tables between the seats or multifunctional tables complete the collection.

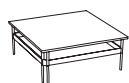
dimension



EIMT hotel table H.35cm (laminated top with MDF core)

Product Options

Style	Tablet Arm Finish	Frame Finishes
1 Table 80×80cm for Angular Composition 90 Deg	AA Oak Asburgo	Powder Coated Finishes
2 Table for composition 45 Deg		
3 Table 30×80cm for linear Compositions		
4 Terminal Table 30×80cm		



EIMT1
EIMT2
EIMT3
EIMT4

Price

853
652
498
467

EIMTDX hotel tablet arm - 30×80cm, H.35cm right DX

Product Options

Tablet Arm Finish AA Oak Asburgo	Frame Finishes Powder Coated Finishes
--	---



EIMTDX

Price

486

EIMTSX hotel tablet arm - 30×80cm H.35cm left SX

Product Options

<p>Tablet Arm Finish</p> <p>AA Oak Asburgo</p>	<p>Frame Finishes</p> <p>Powder Coated Finishes</p>
---	--



EIMTSX

Price

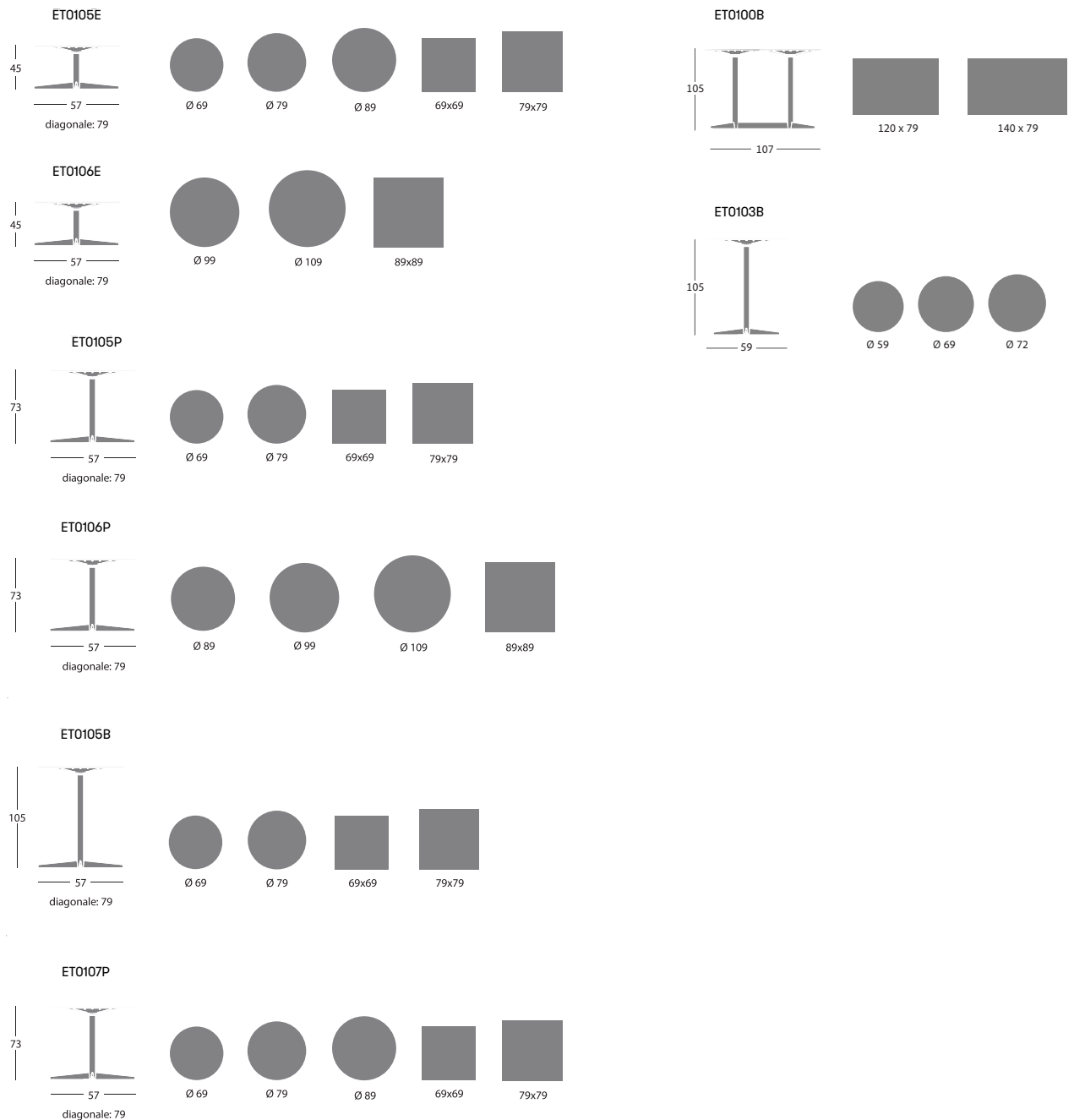
486

samu by segis

features

System of tables and low tables to meet all needs in the contract environment. Different models with either four-spoke or two-spoke bases can be combined with various tabletops. The linear design of the bases, available in three heights, are made in steel profile powder coated in the new black nickel and bronze finishes as well as in a range of various colours. Decorative ceramic tops in different finishes, laminate on plywood, or HPL provide endless style possibilities.

dimension

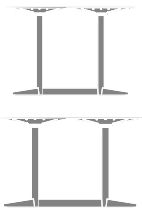


ET0100 samu table base 2 spokes

Product Options

Style	Frame Finish
P Height 73cm	Powder Coated Finishes
B Height 105cm	

Notes Tops are not included, order separately.



	Price
ET0100B	381
ET0100P	363

ET0103 samu table base 3 spokes

Product Options

Style	Frame Finish
P Height 73cm	Powder Coated Finishes
B Height 105cm	

Notes Tops are not included, order separately.



	Price
ET0103B	462
ET0103P	440

ET0105 samu table base 4 spokes

Product Options

Style	Frame Finish
E Height 45cm	Powder Coated Finishes
P Height 73cm	
B Height 105cm	

Notes Tops are not included, order separately.



	Price
ET0105E	421
ET0105P	441
ET0105B	460

ET0106 samu table base 4 spokes with die cast alum fixing plate

Product Options

Style	Frame Finish
E Height 45cm	Powder Coated Finishes
P Height 73cm	

Notes Tops are not included, order separately.



	Price
ET0106E	482
ET0106P	502

ET0107 samu table base 4 spokes with folding mechanism

Product Options

Style	Frame and Top Finish
P Height 73cm	Powder Coated Finishes

Notes Tops are not included, order separately.



	Price
ET0107P	496

EPHP boom/samu table hpl tops

Product Options

Top Size		Top Finish	
T049	Round, Dia.49cm	BI	White 0001 R
T059	Round, Dia.59cm	GG	Grey 527
T069	Round, Dia.69cm	AA	Oak Asburgo 4519
T079	Round, Dia.79cm	RG	Oak Grey 4511
T089	Round, Dia.89cm	CC	Copperfield Grey 3192
T099	Round, Dia.99cm	CR	Corten 3276
T119	Round, Dia.119cm	MB	White Marble 5547
T129	Round, Dia.129cm	MN	Black Marble 6076
T149	Round, Dia.149cm	MG	Grey/Gold Marble 6089
Q069	Square, 69×69cm	NR	Fenix NR
Q079	Square, 79×79cm		
Q089	Square, 89×89cm		
Q099	Square, 99×99cm		
Q119	Square, 119×119cm		
R120	Rectangular, 120×79cm		
R140	Rectangular, 140×79cm		
R160	Rectangular, 160×79cm		
R165	Rectangular, 160×65cm		
R180	Rectangular, 180×79cm		
R200	Rectangular, 200×79cm		

Notes TOP SIZE (T049) or (T059) are not available with HPL finish
 Must order MC060 (metal reinforcement)for tops with length more than 140cm

Price

	HPL1 Finish	HPL2 Finish	HPL3 Finish	HPLNR Finish
EPHPQ069	470	487	511	731
EPHPQ079	579	579	617	871
EPHPQ089	742	733	777	1321
EPHPQ099	832	927	971	1462
EPHPQ119	1240	1328	1487	2350
EPHPR120	952	927	969	1567
EPHPR140	1154	982	1022	1807
EPHPR160	1070	1154	1174	1883
EPHPR165	1070	1154	1174	1883
EPHPR180	2380	1260	1447	2753
EPHPR200	1288	1387	1487	2478
EPHPT049	N/A	317	337	541
EPHPT059	N/A	341	357	637
EPHPT069	470	487	511	731
EPHPT079	579	579	617	871
EPHPT089	742	733	777	1321
EPHPT099	879	927	971	1484
EPHPT119	1273	1328	1487	2350
EPHPT129	1625	1843	1982	3171
EPHPT149	1854	1982	1982	3370

EC060 **samu plp and php metal reinforcement**

	Price
EC060	151

EPLT laminate on chipboard with ABS edge table tops

Product Options

Top Size	Top Finish
T049 Round, Dia.49 cm	Laminate
T059 Round, Dia.59 cm	AA Oak Asburgo 4519
T069 Round, Dia.69 cm	BI White 0001 R
T079 Round, Dia.79 cm	CC Copperfield Grey 3192
T089 Round, Dia.89 cm	CR Corten 3276
T099 Round, Dia.99 cm	GG Grey 527
T120 Round, Dia.119 cm	MB White Marble 5547
T130 Round, Dia.129 cm	MN Black Marble 6076
T150 Round, Dia.149 cm	MG Grey/Gold Marble 6089
Q069 Square, 69×69 cm	LAMNR
Q079 Square, 79×79 cm	NR Fenix NR
Q089 Square, 89×89 cm	
Q119 Square, 119×119 cm	
R120 Rectangular, 120×79 cm	
R140 Rectangular, 140×79 cm	
R160 Rectangular, 160×79 cm	
R165 Rectangular, 160×65 cm	
R180 Rectangular, 180×79 cm	
R200 Rectangular, 200×79 cm	

Price

	Laminate Finish	LAMNR Finish
EPLTQ069	317	427
EPLTQ079	407	551
EPLTQ089	487	670
EPLTQ099	407	923
EPLTQ119	863	1185
EPLTR120	630	848
EPLTR140	705	962
EPLTR160	733	1022
EPLTR165	733	1022
EPLTR180	907	1233
EPLTR200	951	1319
EPLTT049	238	317
EPLTT059	253	337
EPLTT069	368	478
EPLTT079	476	621
EPLTT089	551	733
EPLTT099	744	971
EPLTT120	1090	1412
EPLTT130	1359	1863
EPLTT150	1685	2260

EPMT metal table tops

Product Options

Top Size	Metal Finish
T060 Round, Dia.59 cm	11 Anthracite
T072 Round, Dia.72 cm	68 Aluminium
T080 Round, Dia.79 cm	26 Red
T092 Round, Dia.92 cm	08 Black
Q070 Square, 69×69 cm	18 Off-White/White
Q080 Square, 79×79 cm	17 Taupe
	32 Beige
	04 Light Grey
	05 Brick
	06 Mustard
	33 Blue
	36 Olive Green
	34 Pickle Green
	23 Dark Grey
	13 Prussian
	56 Yale
	54 Asparagus
	53 Macaroon
	46 Light Grey
	47 Tawny
	49 Gingerbread
	48 Pecan

	Price
EPMTQ070	513
EPMTQ080	546
EPMTT060	328
EPMTT072	361
EPMTT080	396
EPMTT092	462

EPNL melamine with abs edge table tops

Product Options

Top Size	Top Finish
T049 Round, Dia.49 cm	Melamine Finish
T059 Round, Dia.59 cm	BN White 2
T069 Round, Dia.69 cm	GS Grey 2
T079 Round, Dia.79 cm	NE Black
T089 Round, Dia.89 cm	
T099 Round, Dia.99 cm	
T120 Round, Dia.119 cm	
T130 Round, Dia.129 cm	
T150 Round, Dia.149 cm	
Q069 Square, 69×69 cm	
Q079 Square, 79×79 cm	
Q089 Square, 89×89 cm	
Q119 Square, 119×119 cm	
R120 Rectangular, 120×79 cm	
R140 Rectangular, 140×79 cm	
R160 Rectangular, 160×79 cm	
R165 Rectangular, 160×65 cm	
R180 Rectangular, 180×79 cm	
R200 Rectangular, 200×79 cm	

	Price
EPNLQ069	178
EPNLQ079	238
EPNLQ089	289
EPNLQ099	407
EPNLQ119	507
EPNLR120	337
EPNLR140	396
EPNLR160	456
EPNLR165	456
EPNLR180	546
EPNLR200	595
EPNLT049	209
EPNLT059	218
EPNLT069	238
EPNLT079	308
EPNLT089	357
EPNLT099	496
EPNLT119	507
EPNLT129	793
EPNLT149	991

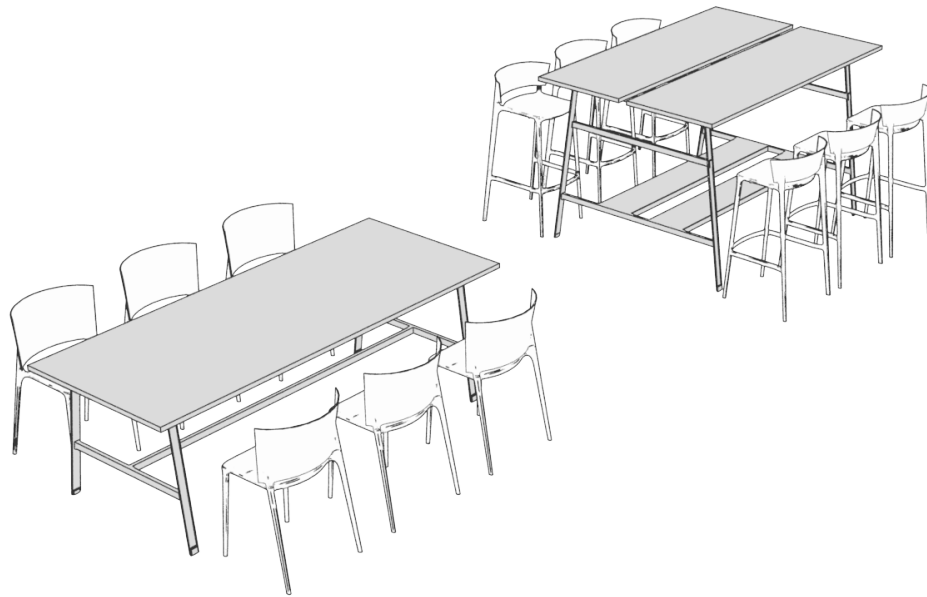
studio tk

rec by studio tk

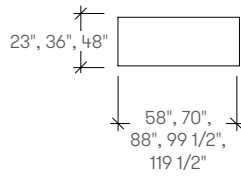
features

Designed by Christophe Pillet, Rec worktables are inspired by the raw, rectangular worktable from the industrial age. Rec creates high work postures ideal for today's social spaces. Rec worktables provide compelling high work settings for the more active worker and creative types – those who need to sit or stand and accomplish solo, heads-down work. Rec supports applications that serve both perimeter and open space planning, for personal touchdown, quick gatherings, and longer-term collaborative work scenarios.

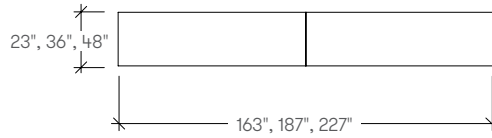
Rec worktables are offered in three popular heights. Two top styles in multiple sizes are available in linoleum, laminate, and veneer. Three base styles are offered in a wide variety of powder coat finishes.



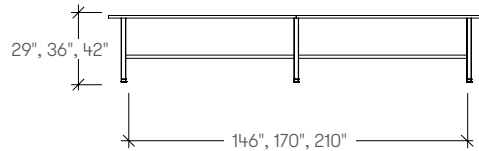
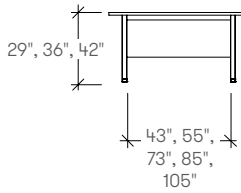
rec dimension



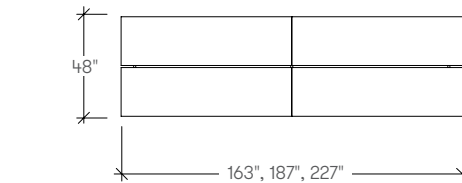
Rec Single Top
Workshop Table
(ESTMA)



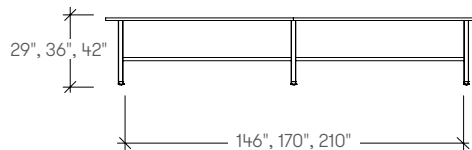
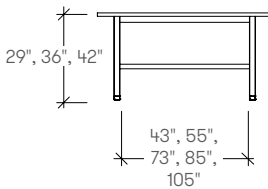
Rec Ganged Single
Top Workshop Tables
(ESTMB)



Rec Split Top
Workshop Table
(ESTMD)



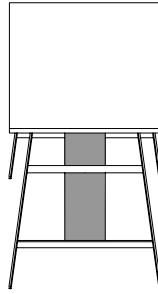
Rec Ganged Split Top
Workshop Table
(ESTMC)



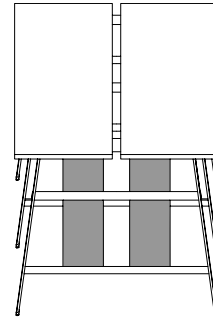
rec details



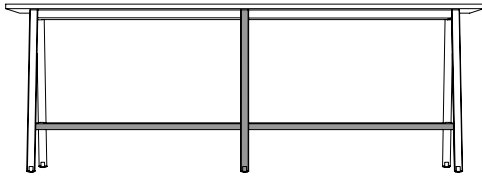
Thin cross rail on the 29" x 29" high or 36" high models of all rec tables



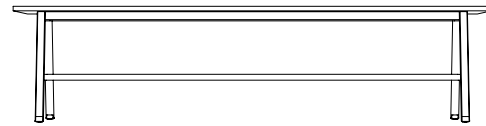
Single footrest on the 42" high x 23" deep or 36" deep tables



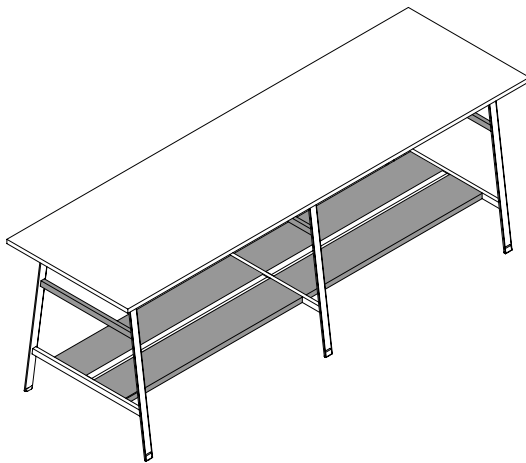
Double footrest on the 42" high x 48" deep tables



The 119" wide tables at 36" and 42" high will now have a third (middle) leg.



The 29" high will remain with 2 legs.



The 36" deep and 48" deep tables at 42" high have a crossbar in the leg for all widths.

ESTMA rec single top workshop table

Product Options

Depth	Width	Height	Power	Surface Finish	Base Finish
A 60cm	A 150cm	29 74cm	N No Power	UK Laminate	Fundamental Paint
D 80cm	F 160cm	42 107cm	P Power Cut Out	Modus Laminate	Modus Paint
B 90cm	B 180cm				
E 100cm	G 200cm				
C 120cm	C 240cm				
	D 260cm				
	E 300cm				



ESTMAAA29N	2282
ESTMAAA29P	2332
ESTMAAA42N	2727
ESTMAAA42P	2776
ESTMAAB29N	2411
ESTMAAB29P	2460
ESTMAAB42N	2855
ESTMAAB42P	2904
ESTMAAC29N	2665
ESTMAAC29P	2714
ESTMAAC42N	3301
ESTMAAC42P	3351
ESTMAAD29N	2791
ESTMAAD29P	2842
ESTMAAD42N	3427
ESTMAAD42P	3477
ESTMAAE29N	3174
ESTMAAE29P	3223
ESTMAAE42N	3808
ESTMAAE42P	3859
ESTMAAF29N	2325
ESTMAAF29P	2375
ESTMAAF42N	2770
ESTMAAF42P	2820
ESTMAAG29N	2496
ESTMAAG29P	2546
ESTMAAG42N	3004
ESTMAAG42P	3054
ESTMABA29N	2665
ESTMABA29P	2715
ESTMABA42N	3174
ESTMABA42P	3223
ESTMABB29N	3045
ESTMABB29P	3095
ESTMABB42N	3556
ESTMABB42P	3604
ESTMABC29N	3236
ESTMABC29P	3285
ESTMABC42N	3936
ESTMABC42P	3985
ESTMABD29N	3427
ESTMABD29P	3477
ESTMABD42N	4126
ESTMABD42P	4176
ESTMABE29N	3618
ESTMABE29P	3668
ESTMABE42N	4319
ESTMABE42P	4367

ESTMA rec single top workshop table (continued)

ESTMABF29N	2792
ESTMABF29P	2842
ESTMABF42N	3301
ESTMABF42P	3350
ESTMABG29N	3109
ESTMABG29P	3158
ESTMABG42N	3683
ESTMABG42P	3733
ESTMACA29N	3301
ESTMACA29P	3351
ESTMACA42N	4253
ESTMACA42P	4302
ESTMACB29N	3682
ESTMACB29P	3731
ESTMACB42N	4636
ESTMACB42P	4685
ESTMACC29N	3873
ESTMACC29P	3922
ESTMACC42N	5208
ESTMACC42P	5257
ESTMACD29N	4253
ESTMACD29P	4302
ESTMACD42N	5588
ESTMACD42P	5639
ESTMACE29N	4762
ESTMACE29P	4812
ESTMACE42N	6225
ESTMACE42P	6275
ESTMACF29N	3428
ESTMACF29P	3478
ESTMACF42N	4381
ESTMACF42P	4431
ESTMACG29N	3746
ESTMACG29P	3796
ESTMACG42N	4827
ESTMACG42P	4877
ESTMADA29N	2537
ESTMADA29P	2587
ESTMADA42N	3025
ESTMADA42P	3074
ESTMADB29N	2834
ESTMADB29P	2883
ESTMADB42N	3322
ESTMADB42P	3371
ESTMADC29N	3046
ESTMADC29P	3095
ESTMADC42N	3724
ESTMADC42P	3774
ESTMADD29N	3215
ESTMADD29P	3265
ESTMADD42N	3893
ESTMADD42P	3943
ESTMADE29N	3470
ESTMADE29P	3520
ESTMADE42N	4149
ESTMADE42P	4198
ESTMADF29N	2636
ESTMADF29P	2686
ESTMADF42N	3124
ESTMADF42P	3173
ESTMADG29N	2904
ESTMADG29P	2954
ESTMADG42N	3456
ESTMADG42P	3507
ESTMAEA29N	2877
ESTMAEA29P	2927
ESTMAEA42N	3534

ESTMA rec single top workshop table (continued)

ESTMAEA42P	3583
ESTMAEB29N	3257
ESTMAEB29P	3307
ESTMAEB42N	3916
ESTMAEB42P	3964
ESTMAEC29N	3448
ESTMAEC29P	3497
ESTMAEC42N	4360
ESTMAEC42P	4409
ESTMAED29N	3702
ESTMAED29P	3752
ESTMAED42N	4613
ESTMAED42P	4664
ESTMAEE29N	3999
ESTMAEE29P	4049
ESTMAEE42N	4954
ESTMAEE42P	5003
ESTMAEF29N	3004
ESTMAEF29P	3054
ESTMAEF42N	3661
ESTMAEF42P	3710
ESTMAEG29N	3321
ESTMAEG29P	3371
ESTMAEG42N	4064
ESTMAEG42P	4114

ESTMB rec ganged single top workshop tables

Product Options

Depth	Width	Height	Power	Surface Finish	Base Finish
A 60cm	I 320cm	29 74cm	N No Power	UK Laminate	Fundamental Paint
D 80cm	J 360cm	42 107cm	P Power Cut Out	Modus Laminate	Modus Paint
B 90cm	K 400cm				
E 100cm	F 420cm				
C 120cm	G 480cm				
	L 520cm				
	H 580cm				
	M 600cm				



Price

ESTMBAF29N	4930
ESTMBAF29P	5028
ESTMBAF42N	6105
ESTMBAF42P	6204
ESTMBAG29N	5164
ESTMBAG29P	5264
ESTMBAG42N	6342
ESTMBAG42P	6440
ESTMBAH29N	5871
ESTMBAH29P	5969
ESTMBAH42N	7046
ESTMBAH42P	7145
ESTMBAI29N	4696
ESTMBAI29P	4792
ESTMBAI42N	5868
ESTMBAI42P	5968
ESTMBAJ29N	4774
ESTMBAJ29P	4871
ESTMBAJ42N	5947
ESTMBAJ42P	6047
ESTMBAK29N	4852
ESTMBAK29P	4949
ESTMBAK42N	6026
ESTMBAK42P	6125
ESTMBAL29N	5447
ESTMBAL29P	5546
ESTMBAL42N	6624
ESTMBAL42P	6722
ESTMBAM29N	6083
ESTMBAM29P	6181
ESTMBAM42N	7257
ESTMBAM42P	7357
ESTMBBF29N	5987
ESTMBBF29P	6085
ESTMBBF42N	7282
ESTMBBF42P	7380
ESTMBBG29N	6342
ESTMBBG29P	6440

ESTMB rec ganged single top workshop tables (continued)

ESTMBBG42N	7634
ESTMBBG42P	7732
ESTMBBH29N	6694
ESTMBBH29P	6792
ESTMBBH42N	7986
ESTMBBH42P	8086
ESTMBBI29N	5632
ESTMBBI29P	5730
ESTMBBI42N	6930
ESTMBBI42P	7028
ESTMBBJ29N	5750
ESTMBBJ29P	5848
ESTMBBJ42N	7047
ESTMBBJ42P	7145
ESTMBBK29N	5869
ESTMBBK29P	5967
ESTMBBK42N	7165
ESTMBBK42P	7263
ESTMBBL29N	6483
ESTMBBL29P	6581
ESTMBBL42N	7775
ESTMBBL42P	7874
ESTMBBM29N	6764
ESTMBBM29P	6862
ESTMBBM42N	8056
ESTMBBM42P	8157
ESTMBCF29N	7163
ESTMBCF29P	7263
ESTMBCF42N	9635
ESTMBCF42P	9733
ESTMBCG29N	7871
ESTMBCG29P	7969
ESTMBCG42N	10341
ESTMBCG42P	10439
ESTMBCH29N	8812
ESTMBCH29P	8910
ESTMBCH42N	11517
ESTMBCH42P	11615
ESTMBCI29N	6455
ESTMBCI29P	6557
ESTMBCI42N	8929
ESTMBCI42P	9027
ESTMBCJ29N	6691
ESTMBCJ29P	6792
ESTMBCJ42N	9164
ESTMBCJ42P	9262
ESTMBCK29N	6927
ESTMBCK29P	7028
ESTMBCK42N	9400
ESTMBCK42P	9498
ESTMBCL29N	8247
ESTMBCL29P	8345
ESTMBCL42N	10811
ESTMBCL42P	10909
ESTMBCM29N	9000
ESTMBCM29P	9098
ESTMBCM42N	11752
ESTMBCM42P	11850
ESTMBDF29N	5635
ESTMBDF29P	5733
ESTMBDF42N	6890
ESTMBDF42P	6988
ESTMBDG29N	5949
ESTMBDG29P	6048
ESTMBDG42N	7203

ESTMB rec ganged single top workshop tables (continued)

ESTMBDG42P	7301
ESTMBDH29N	6420
ESTMBDH29P	6518
ESTMBDH42N	7673
ESTMBDH42P	7772
ESTMBDI29N	5320
ESTMBDI29P	5417
ESTMBDI42N	6576
ESTMBDI42P	6675
ESTMBDJ29N	5425
ESTMBDJ29P	5522
ESTMBDJ42N	6681
ESTMBDJ42P	6779
ESTMBDK29N	5530
ESTMBDK29P	5628
ESTMBDK42N	6785
ESTMBDK42P	6884
ESTMBDL29N	6137
ESTMBDL29P	6236
ESTMBDL42N	7391
ESTMBDL42P	7490
ESTMBDM29N	6537
ESTMBDM29P	6635
ESTMBDM42N	7790
ESTMBDM42P	7890
ESTMBEF29N	6379
ESTMBEF29P	6478
ESTMBEF42N	8066
ESTMBEF42P	8164
ESTMBEG29N	6852
ESTMBEG29P	6950
ESTMBEG42N	8536
ESTMBEG42P	8634
ESTMBEH29N	7400
ESTMBEH29P	7498
ESTMBEH42N	9163
ESTMBEH42P	9262
ESTMBEI29N	5906
ESTMBEI29P	6006
ESTMBEI42N	7596
ESTMBEI42P	7694
ESTMBEJ29N	6064
ESTMBEJ29P	6163
ESTMBEJ42N	7753
ESTMBEJ42P	7851
ESTMBEK29N	6221
ESTMBEK29P	6320
ESTMBEK42N	7910
ESTMBEK42P	8008
ESTMBEL29N	7071
ESTMBEL29P	7169
ESTMBEL42N	8787
ESTMBEL42P	8886
ESTMBEM29N	7510
ESTMBEM29P	7608
ESTMBEM42N	9288
ESTMBEM42P	9388

ESTMD rec split top workshop table

Product Options

Depth	Width	Height	Surface Finish	Base Finish
C 120cm	A 150cm	29 74cm	UK Laminate	Fundamental Paint
	F 160cm	42 107cm	Modus Laminate	Modus Paint
	B 180cm			
	G 200cm			
	C 240cm			
	D 260cm			
	E 300cm			



ESTMDCA29
 ESTMDCA42
 ESTMDCB29
 ESTMDCB42
 ESTMDCC29
 ESTMDCC42
 ESTMDCD29
 ESTMDCD42
 ESTMDCE29
 ESTMDCE42
 ESTMDCF29
 ESTMDCF42
 ESTMDCG29
 ESTMDCG42

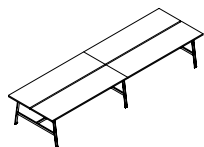
Price

3808
4762
4064
5017
4319
5653
4571
5907
5080
6416
3893
4847
4149
5229

ESTMC rec ganged split top workshop table

Product Options

Depth	Width	Height	Surface Finish	Base Finish
C 120cm	I 320cm	29 74cm	UK Laminate	Fundamental Paint
	J 360cm	42 107cm	Modus Laminate	Modus Paint
	K 400cm			
	F 420cm			
	G 480cm			
	L 520cm			
	H 580cm			
	M 600cm			



ESTMCCF29
 ESTMCCF42
 ESTMCCG29
 ESTMCCG42
 ESTMCCH29
 ESTMCCH42
 ESTMCCI29
 ESTMCCI42
 ESTMCCJ29
 ESTMCCJ42
 ESTMCCK29
 ESTMCCK42
 ESTMCCL29
 ESTMCCL42
 ESTMCCM29
 ESTMCCM42

Price

7986
 10459
 8459
 10928
 9400
 11869
 7395
 9521
 7513
 9756
 7750
 10225
 8835
 11304
 11587
 11869

ELSRTM rec desk top module

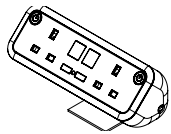
Product Options

Style	Country of Installation	Power Finish
C 2 Power, 1 USB-C / 1 USB-A (25w)	01 UK/Ireland	BB Black + black
H High Capacity 2 Power, 1 USB-C / 1 USB-A (100w)	02 Europe	WW White + white
	03 Denmark	
	04 Swiss	

Price

ELSRTMC
ELSRTMH

	UK/Ireland	Europe	Denmark	Swiss
ELSRTMC	417	221	417	417
ELSRTMH	902	954	954	954



ELSRIM rec in desk module

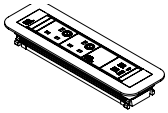
Product Options

Style	Country of Installation	Power Finish
C 2 Power, 1 USB-C / 1 USB-A (25w)	01 UK/Ireland 02 Europe 03 Denmark 04 Swiss	BD Black + Dark Grey BG Black + Grey

Price

ELSRIMC

UK/Ireland	Europe	Denmark	Swiss
892	991	991	991



ELSRSC rec starter cables power

Product Options

Plug options	Length	Country of Installation	Power Finish
2 Plug	2 2 meter 3 3 meter 5 5 meter	01 UK/Ireland 02 Europe 03 Denmark 04 Swiss	BB Black + black WW White + white

Price



ELSRSC22
ELSRSC23
ELSRSC25

	UK/Ireland	Europe	Denmark	Swiss
ELSRSC22	42	47	60	60
ELSRSC23	48	56	80	80
ELSRSC25	60	104	120	120

true design

wing by true design

features

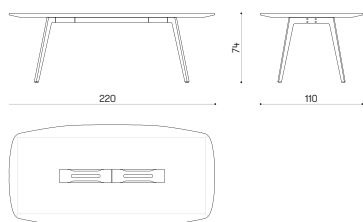
WING is a table created for working areas, but it can also fit inside a home-office or domestic environment. It is characterized by a wooden frame inspired by the sawhorse of the working tables, and the rounded shape of the top with its contemporary lines. Defined by great flexibility, WING can be completed with acoustic panels, a brass reading lamp and wooden or metal trays that are installed on the large central channel through a magnetic fixing system. Power supply and cable management are allocated on the same central channel.

dimension

MEETING

EWI220

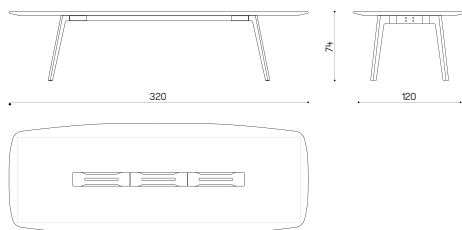
table 220x110x74 cm



📦 kg 60m 📐 c 179

EWI320

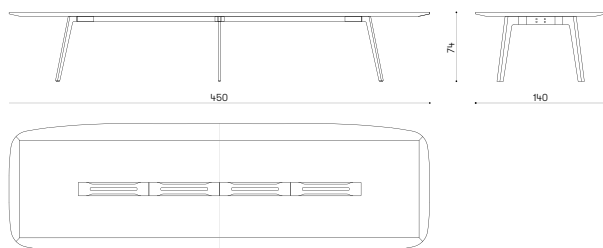
table 320x120x74 cm



📦 kg 72m 📐 c 2,8

EWI450

table 450x140x74 cm



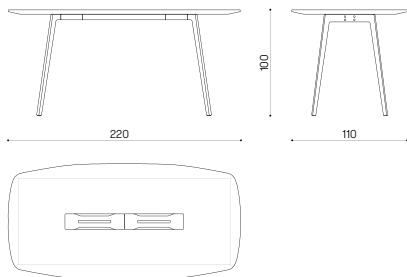
📦 kg 126 📐 mc 4,6

dimension

HIGH MEETING

EWI220H

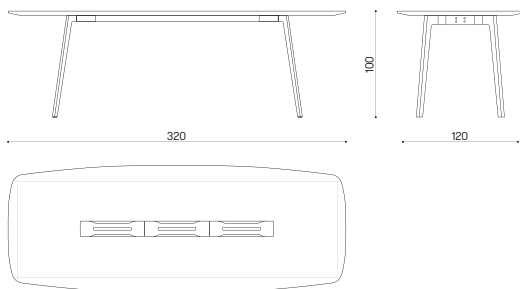
high table 220x110x100 cm



📦 kg 60m 🌀 c 2,42

EWI320H

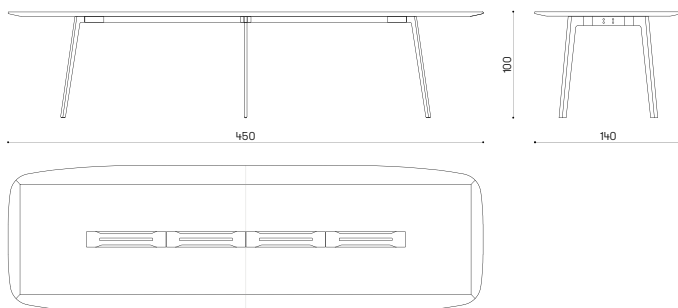
high table 320x120x100 cm



📦 kg 72m 🌀 c 3,8

EWI450H

high table 450x140x100 cm



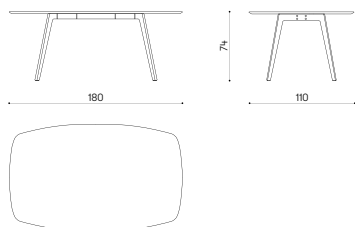
📦 kg 126 🌀 mc 6,3

dimension

WORKING TABLE

EWI180

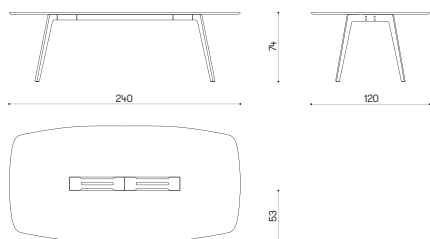
Laminate top, solid beechwood legs - 180x110 cm



⚖ kg 60m 📦 c 1,4

EWI240

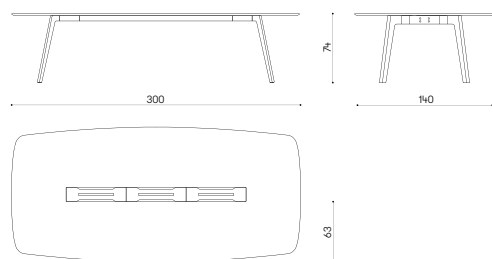
Laminate top, solid beechwood legs - 240x120 cm



⚖ kg 72 📦 mc 2,1

EWI300

Laminate top, solid beechwood legs - 300x140 cm

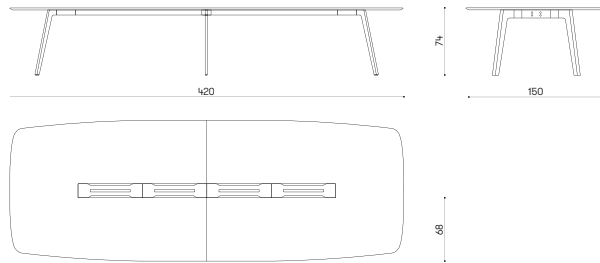


⚖ kg 126m 📦 c 3,1

dimension

EWI420

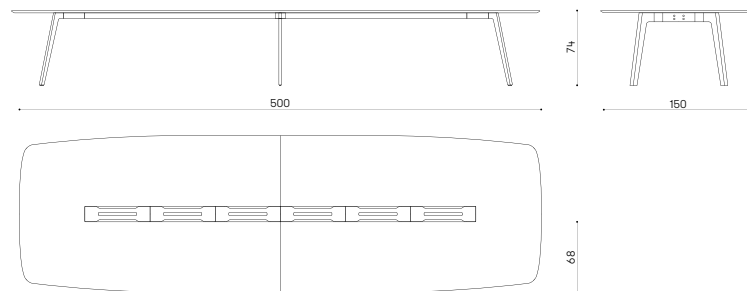
Laminate top, solid beechwood legs - 420x150 cm



kg 140m c 4,9

EWI500

Laminate top, solid beechwood legs - 500x150 cm

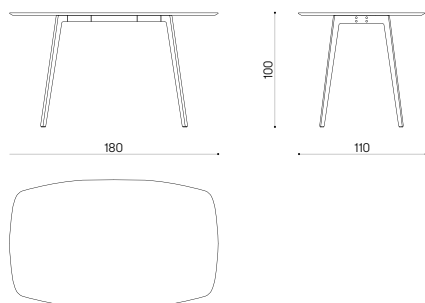


dimension

HIGH WORKING TABLE

EWI180H

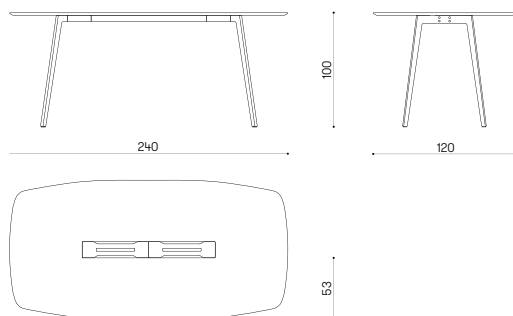
high table 180x110x100 cm



kg 60m mc 1,9

EWI240H

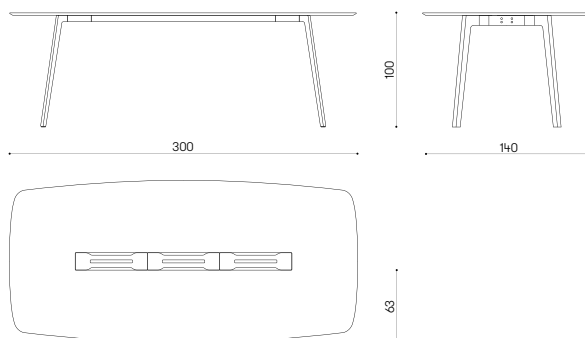
high table 240x120x100 cm



kg 72 mc 2,8

EWI300H

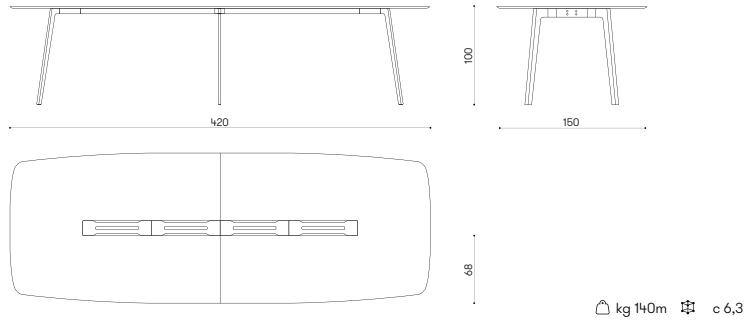
high table 300x140x100 cm



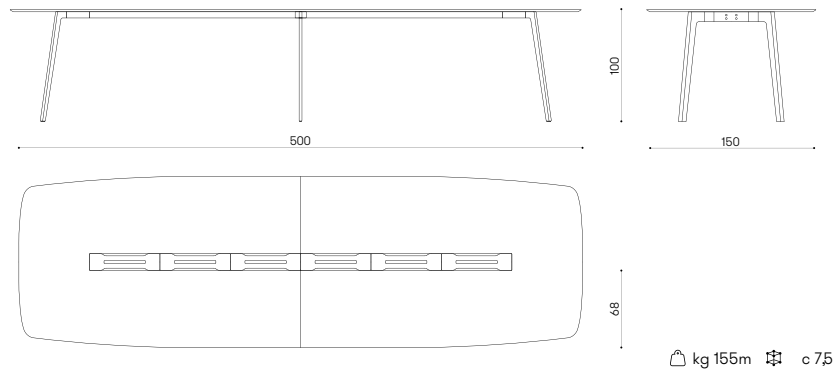
kg 126m mc 4,2

dimension

EWI420H
high table 420x150x100 cm



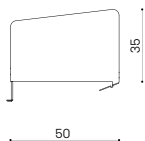
EWI500H
high table 500x150x100 cm



dimension

EWI22PL

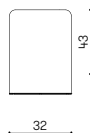
side dividing panel for Wing tables depth 110 cm



m 0,7 ⬡ mq 1,19 ⬢ kg 1,8 ⚙ mc 0,057

EWI22PC

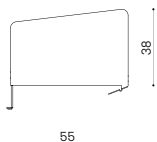
central dividing panel for Wing tables width 220cm



m 0,4 ⬡ mq 0,74 ⬢ kg 1m ⚙ c 0,04

EWI32PL

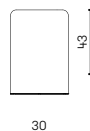
side dividing panel for Wing tables depth 120cm



m 0,7 ⬡ mq 1,2 ⬢ kg 2m ⚙ c 0,057

EWI30PC

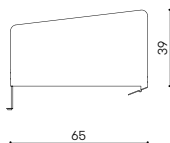
central dividing panel for Wing tables width 300cm



m 0,4 ⬡ mq 0,74 ⬢ kg 1m ⚙ c 0,04

EWI45PL

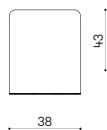
side dividing panel for Wing tables depth 140cm



m 0,96 ⬡ mq 1,6 ⬢ kg 2,5m ⚙ c 0,076

EWI32PC

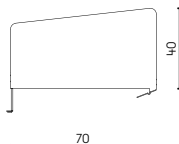
central dividing panel for Wing tables width 320cm



m 0,45 ⬡ mq 0,8 ⬢ kg 1,2m ⚙ c 0,046

EWI50PL

side dividing panel for Wing tables depth 150cm



m 1,00 ⬡ mq 1,65 ⬢ kg 2,7m ⚙ c 0,08

EWI45PC

central dividing panel for Wing tables width 450cm



m 0,55 ⬡ mq 0,93 ⬢ kg 1,5m ⚙ c 0,066

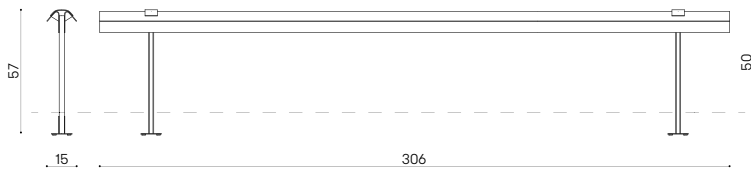
dimension

EWI LB32
reading lamp for WI 320



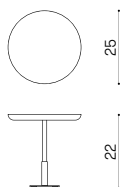
3000k led lamp, 2 mt.o f cable, socket, on/off button

EWI LB45
reading lamp for WI 450



3000k led lamp, 2 mt.o f cable, socket, on/off button

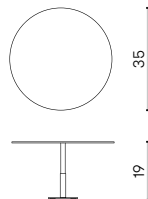
EWI TW25
oakwood plate



kg 1

mc 0,08m

EWI TW35
iron plate



kg 1

c 0,08

EWI22PC wing central dividing panel for wing tables depth 220cm
EWI30PC wing central dividing panel for wing tables depth 300cm
EWI32PC wing central dividing panel for wing tables depth 320cm
EWI45PC wing central dividing panel for wing tables depth 450cm

Product Options

Upholstery Finish

- Group S
- Group T
- Group M
- Group F
- Group L
- Group P
- Group PX

Price



EWI22PC

COM	COL	Gr.1	Gr.2	Gr.3	Gr.4	Gr.5	Gr.6	Gr.7	Gr.8	Gr.9	Gr.10
248	300	279	290	300	311	321	331	342	352	363	373

Leather LC	Leather LD
487	498



EWI30PC

COM	COL	Gr.1	Gr.2	Gr.3	Gr.4	Gr.5	Gr.6	Gr.7	Gr.8	Gr.9	Gr.10
238	290	290	311	331	352	373	394	415	435	456	477

Leather LC	Leather LD
705	726



EWI32PC

COM	COL	Gr.1	Gr.2	Gr.3	Gr.4	Gr.5	Gr.6	Gr.7	Gr.8	Gr.9	Gr.10
367	419	419	439	460	481	502	523	543	564	585	606

Leather LC	Leather LD
834	855



EWI45PC

COM	COL	Gr.1	Gr.2	Gr.3	Gr.4	Gr.5	Gr.6	Gr.7	Gr.8	Gr.9	Gr.10
369	421	421	442	462	483	504	525	545	566	587	608

Leather LC	Leather LD
836	857

EWI22PL wing side dividing panel for wing tables depth 110cm
EWI32PL wing side dividing panel for wing tables depth 120cm
EWI45PL wing side dividing panel for wing tables depth 140cm
EWI50PL wing side dividing panel for wing tables depth 150cm

Product Options

Upholstery Finish

- Group S
- Group T
- Group M
- Group F
- Group L
- Group P
- Group PX

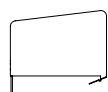
Price



EWI22PL

COM	COL	Gr.1	Gr.2	Gr.3	Gr.4	Gr.5	Gr.6	Gr.7	Gr.8	Gr.9	Gr.10
467	518	518	539	560	581	602	622	643	664	685	705

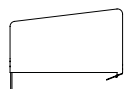
Leather LC	Leather LD
934	955



EWI32PL

COM	COL	Gr.1	Gr.2	Gr.3	Gr.4	Gr.5	Gr.6	Gr.7	Gr.8	Gr.9	Gr.10
467	518	518	539	560	581	602	622	643	664	685	705

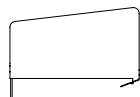
Leather LC	Leather LD
934	955



EWI45PL

COM	COL	Gr.1	Gr.2	Gr.3	Gr.4	Gr.5	Gr.6	Gr.7	Gr.8	Gr.9	Gr.10
500	552	562	593	624	656	687	718	749	780	811	843

Leather LC	Leather LD
1185	1217



EWI50PL

COM	COL	Gr.1	Gr.2	Gr.3	Gr.4	Gr.5	Gr.6	Gr.7	Gr.8	Gr.9	Gr.10
508	560	570	602	633	664	695	726	757	789	820	851

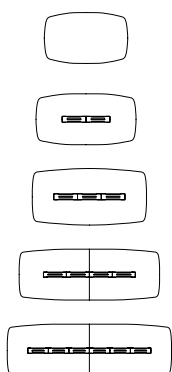
Leather LC	Leather LD
1194	1225

- EWI180 **wing** working table 180 × 110cm
- EWI240 **wing** working table 240 × 120cm
- EWI300 **wing** working table 300 × 140cm
- EWI420 **wing** working table 420 × 150cm
- EWI500 **wing** working table 500 × 150cm

Product Options

Surface Finishes	Surface Finishes
Laminate Plywood	Solid Oakwood Beechwood

Notes Splitted table top add 864 for EWI300 only



- EWI180
- EWI240
- EWI300
- EWI420
- EWI500

Price

	Laminate Plywood + Beechwood	Laminate Plywood + Solid Oakwood
EWI180	5817	6062
EWI240	6948	7192
EWI300	9294	9679
EWI420	12545	13073
EWI500	16129	16657

EWI220 wing meeting table 220 × 110 × 74cm
 EWI320 wing meeting table 320 × 120 × 74cm
 EWI450 wing meeting table 450 × 140 × 74cm


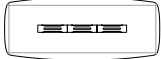

Product Options

Surface & Leg Finishes

Black/decorated HPL Top + Solid Oakwood Legs
 Full Core HPL/White + Solid Oakwood Legs
 Oakwood Top + Solid Oakwood Legs
 Walnut Top + Solid Walnut Legs

Notes Splitted table top add 864 for EWI320 only

Price

	Black/HPL Top+ Solid Oakwood	Full Core HPL White + Solid Oakwood	Oakwood Top + Solid Oakwood	Walnut Top+ Solid Walnut
 EWI220	8021	9429	11367	15113
 EWI320	12200	15693	16470	20987
 EWI450	19058	22763	21221	26576

EWI180H	wing high working table 180 × 110 × 100cm
EWI240H	wing high working table 240 × 120 × 100cm
EWI300H	wing high working table 300 × 140 × 100cm
EWI420H	wing high working table 420 × 150 × 100cm
EWI500H	wing high working table 500 × 150 × 100cm

Product Options

<p>Surface Finishes</p> <p>Laminate Plywood</p>	<p>Surface Finishes</p> <p>Steel leg</p>
--	---

Notes

- Custom color frame add 201 for EWI180H and EWI240H
- Custom color frame add 223 for EWI300H only
- Splitted table top add 864 for EWI300H only
- Custom color frame add 337 for EWI420H and EWI500H only

		Price
	EWI180H	5817
	EWI240H	6948
	EWI300H	9294
	EWI420H	12545
	EWI500H	16129

EWI220H wing high meeting table 220 × 110 × 100cm
EWI320H wing high meeting table 320 × 120 × 100cm
EWI450H wing high meeting table 450 × 140 × 100cm

Product Options

Surface Finishes	Surface Finishes
Black/decorated HPL Top Full Core HPL/White Plywood Top Wooden Top	Steel Leg

Notes Custom color frame add 201 for EWI220H only
 Splitted table top add 864 for EWI320H only
 Custom color frame add 223 for EWI320H only
 Custom color frame add 337 for EWI450H only

Price



EWI220H



EWI320H

EWI450H



	Black/HPL Top+ Solid Oakwood	Full Core HPL White + Solid Oakwood	Oakwood Top + Solid Oakwood	Walnut Top+ Solid Walnut
EWI220H	8021	9429	11367	15113
EWI320H	12200	15693	16470	20987
EWI450H	19058	22763	21221	26576

EWITW25 wing oakwood plate

Product Options

Wooden Finishes

NK Natural Oakwood

	Price
EWITW25	305

EWITS35 wing iron plate

Product Options

Finishes	
90005	Black
9010	White
Std Color	

	Price
EWITS32	353

EWILB32 **wing** reading lamp for WI320
EWILB45 **wing** reading lamp for WI450

Product Options

Type

Brass
Steel

Price

EWILB32	Steel	Brass
	3838	8080

EWILB45	Steel	Brass
	4899	10727

wilkhahn

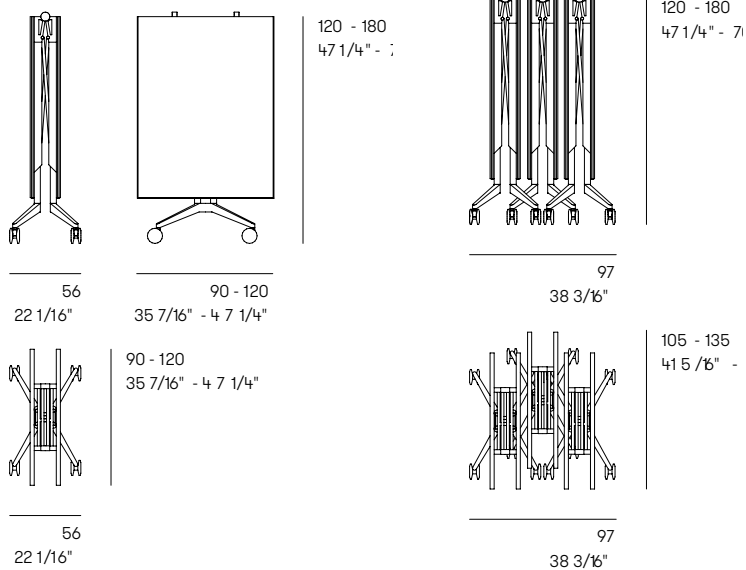
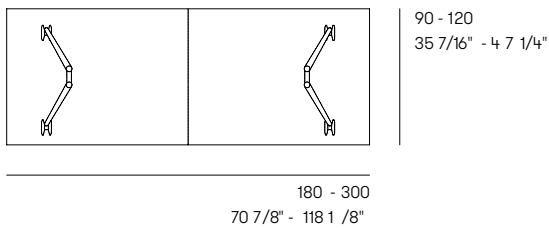
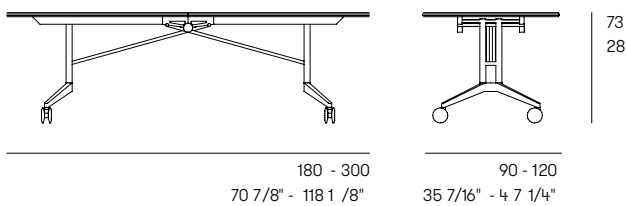
confair by wilkhahn

features

Confair folding tables make versatile usage of cleverly designed conference and meeting areas child's play. Only one single person is required to set up and rearrange the movable folding tables – without any tools, releasing or unlocking procedures or special skills involved. Snap connectors allow the tables to be linked in any direction. If partitions are used to divide up rooms, conference or project work tables can be transformed into a large conference layout in no time.

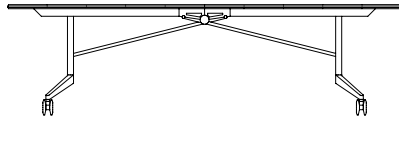
dimension

confair table basic

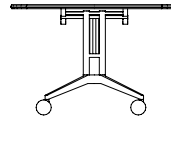


dimension

confair table standard

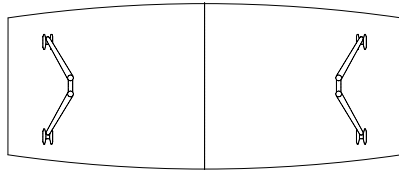


180 - 280
70 7/8" - 110 1/4"



90/110 - 120
35 7/16" / 43 5/16" - 47 1/4"

73
28 3/4"



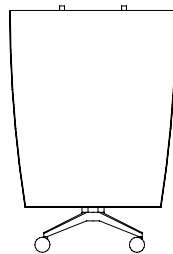
180 - 280
70 7/8" - 110 1/4"

90/110 - 120
35 7/16" / 43 5/16" - 47 1/4"

440/2

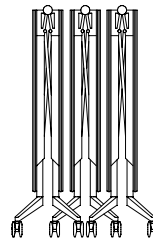


56
22 1/16"



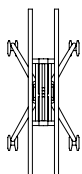
110 - 120
43 5/16" - 47 1/4"

120 - 180
47 1/4" - 70 7/8"



97
38 3/16"

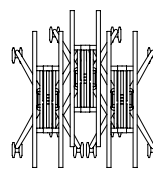
120 - 180
47 1/4" - 70 7/8"



56
22 1/16"

110 - 120
43 5/16" - 47 1/4"

440/2

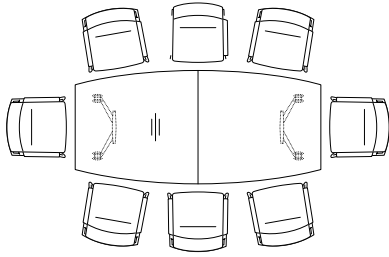


97
38 3/16"

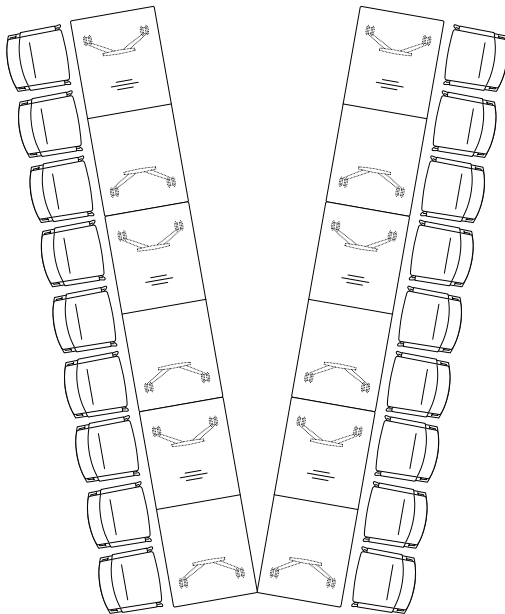
105 - 135
41 5/16" - 5 3/8"

planning

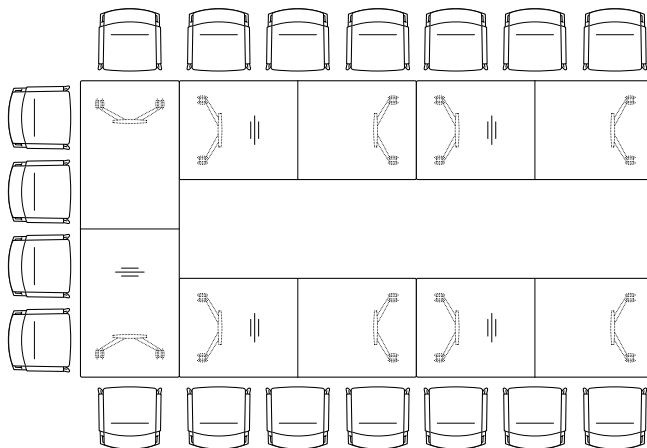
8 people



16 people



18 people



E440-00B confair table basic

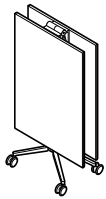
Product Options

Width	Depth	Top Surface	Edge
180 1800	080 800	Laminex, Solid Colour	ABS Square Edge, R2
200 2000	090 900		
220 2200	100 1000		
240 2400	110 1100		
260 2600	120 1200		
280 2800			
300 3000			

Under frame	Frame Upright	Foot Sections	Connectors
Steel, Black Coated	Tubular Steel, Black Coated	Aluminium, Black Coated	612 Polyamide

Notes 1100 depth is not available if 3000 width is selected.
1200 depth is not available if 2800 width and 3000 width is selected.

Price



180 / 080	15846
180 / 090	16202
180 / 100	16560
180 / 110	16910
180 / 120	17265
200 / 080	16786
200 / 090	17167
200 / 100	17539
200 / 110	17914
200 / 120	18293
220 / 080	17265
220 / 090	17660
220 / 100	18068
220 / 110	18463
220 / 120	18869

E440-00B confair table basic (continued)

	Price
240 / 080	17677
240 / 090	18099
240 / 100	18533
240 / 110	18959
240 / 120	19384
260 / 080	17890
260 / 090	18349
260 / 100	18799
260 / 110	19253
260 / 120	19694
280 / 080	18505
280 / 090	18989
280 / 100	19473
280 / 110	19944
300 / 080	18760
300 / 090	19255
300 / 100	19753

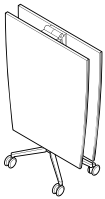
E440-00S confair table standard

Product Options

Width	Depth	Top Surface	Edge
180 1800	080 800	Laminex, Woodgrain	Round Solid Timber w. Rubber
200 2000	090 900		
220 2200	100 1000		
240 2400	110 1100		
260 2600	120 1200		
280 2800			
300 3000			

Under frame	Frame Upright	Foot Sections	Connectors
Steel, Black Coated	Tubular Steel, Black Coated	Aluminium, Polished	612 Polyamide

Notes 1100 depth is not available if 3000 width is selected.
1200 depth is not available if 2800 width and 3000 width is selected.



Price

180 / 080	17391
180 / 090	17906
180 / 100	18415
180 / 110	18944
180 / 120	19454
200 / 080	18463
200 / 090	19023
200 / 100	19577
200 / 110	20137
200 / 120	20679
220 / 080	19093
220 / 090	19692
220 / 100	20282
220 / 110	20872
220 / 120	21466

E440-00S **confair** table standard (continued)

	Price
240 / 080	19653
240 / 090	20288
240 / 100	20923
240 / 110	21555
240 / 120	22191
260 / 080	20008
260 / 090	20697
260 / 100	21368
260 / 110	22039
260 / 120	22723
280 / 080	20788
280 / 090	21500
280 / 100	22222
280 / 110	22927
300 / 080	21175
300 / 090	21936
300 / 100	22678

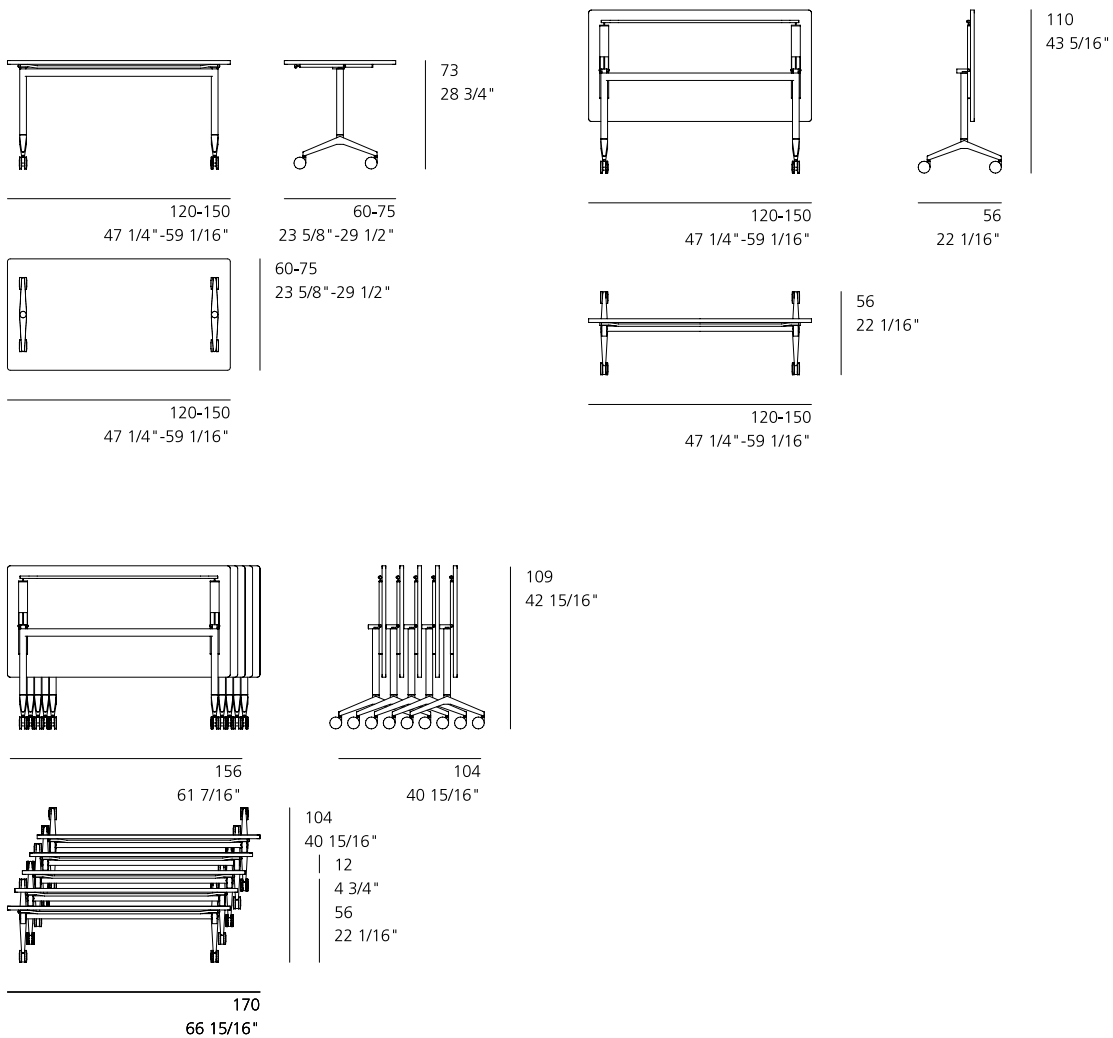
timetable by wilkhahn

features

Timetable's table tops flip up in one easy step and the foot sections turn inward in the process. As a result, they're easy to move from room to room and nest very compactly into one another. Intuitive handling, exceptional quality and a strong aesthetic inspire a change of methods and save resources, time and space. The exceptionally hard-wearing Timetable Smart with its power solutions has uncovered further usage potential and found its way into hot desking, training and project spaces. The frame design of its big brother (Timetable Shift) means it can be combined perfectly with Confair folding tables and Logon tables. The U-shaped aluminum profile to help connect the legs also provides a spacious cable channel at the same time. Timetable comes in lots of different formats, shapes, edges and surfaces.

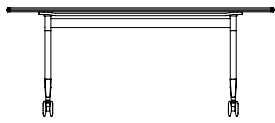
dimension

Timetable Smart 612

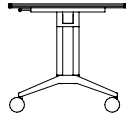


dimension

Timetable Lift 614

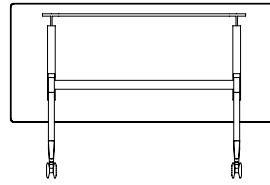


150-210
59 1/16"-82 11/16"

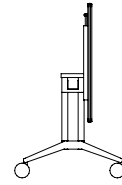


80-105
31 1/2"-41 5/16"

73
28 3/4"



150-210
59 1/16"-82 11/16"



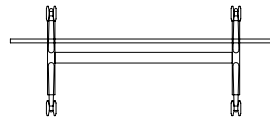
115-130
45 1/4"-51 3/16"

67
26 3/8"



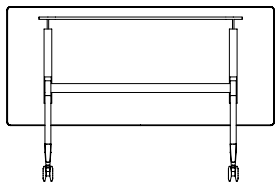
150-210
59 1/16"-82 11/16"

80-105
31 1/2"-41 5/16"

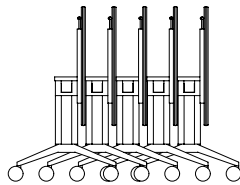


150-210
59 1/16"-82 11/16"

67
26 3/8"

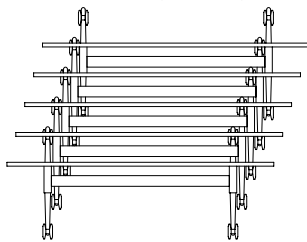


150-210
59 1/16"-82 11/16"



147
57 7/8"

115-130
45 1/4"-51 3/16"

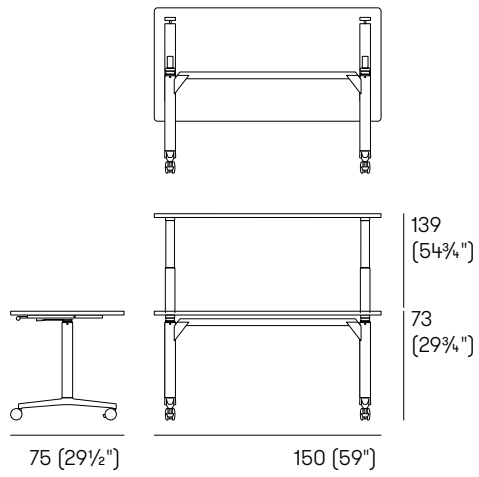


150-210
59 1/16"-82 11/16"

147
57 7/8"
20
7 7/8"
67
26 3/8"

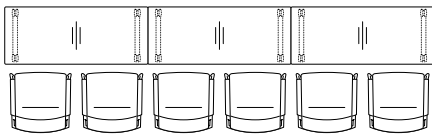
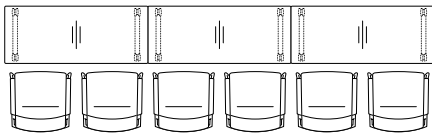
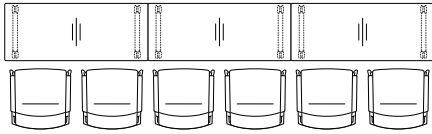
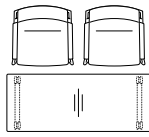
dimension

Timetable Lift 615



planning

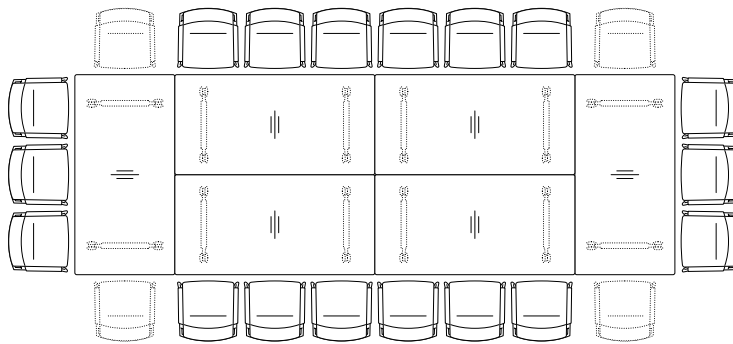
Timetable Smart 612



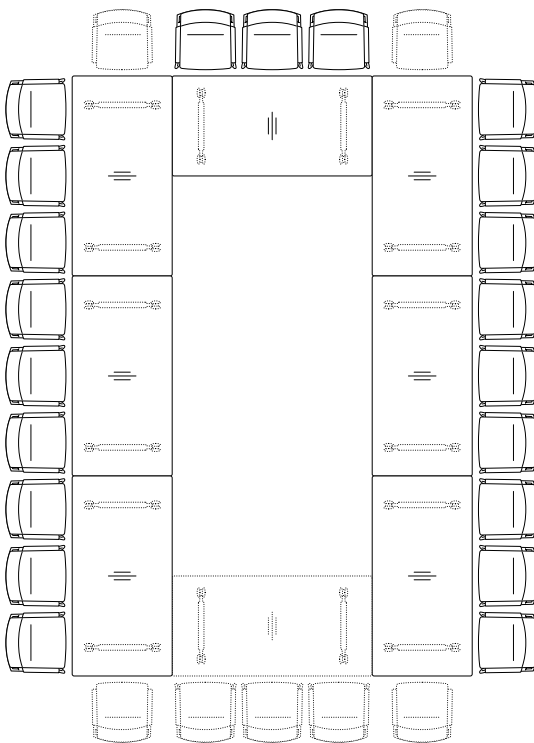
20 people

planning

Timetable Shift 614



18 (22) people



21 (28) people

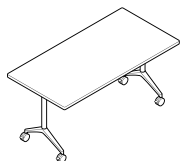
E612-00B timetable smart basic

Product Options

Width	Depth	Top Surface	Edge
120 1200	070 700	Pre-laminated Board	ABS Square Edge, R2
130 1300	075 750		
140 1400	080 800		
150 1500			
160 1600			
180 1800			

Under frame	Frame Upright	Foot Sections	Connectors
Steel, Black Coated	Tubular Steel, Black Coated	Aluminium, Black Coated	612 Polyamide

Notes 700 depth is not available if 1500, 1600 and 1800 width are selected.



	Price
120 / 070	8469
120 / 075	8578
120 / 080	8692
130 / 070	8620
130 / 075	8740
130 / 080	8855
140 / 070	8783
140 / 075	8900
140 / 080	9191
150 / 075	9054
150 / 080	9191
160 / 075	9224
160 / 080	9365
180 / 075	9546
180 / 080	9703

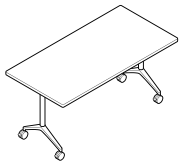
E612-00S timetable smart standard

Product Options

Width	Depth	Top Surface	Edge
120 1200	070 700	Laminex Commercial Range	Round Solid Timber w. Rubber
130 1300	075 750		
140 1400	080 800		
150 1500			
160 1600			
180 1800			

Under frame	Frame Upright	Foot Sections	Connectors
Steel, Black Coated	Tubular Steel, Black Coated	Aluminium, Polished	612 Polyamide

Notes 700 depth is not available if 1500, 1600 and 1800 width are selected.



Price

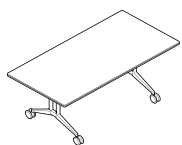
120 / 070	9277
120 / 075	9440
120 / 080	9591
130 / 070	9496
130 / 075	9655
130 / 080	9826
140 / 070	9712
140 / 075	9888
140 / 080	10067
150 / 075	10118
150 / 080	10302
160 / 075	10333
160 / 080	10526
180 / 075	10775
180 / 080	10999

E614-00S timetable shift standard

Product Options

Width	Depth	Top Surface	Edge
150 1500	075 750	Laminex Commercial Range	Round Solid Timber w. Rubber
160 1600	080 800		
170 1700	090 900		
180 1800	100 1000		
190 1900			
200 2000			
210 2100			

Under frame	Frame Upright	Foot Sections	Connectors
Steel, Black Coated	Tubular Steel, Black Coated	Aluminium, Polished	612 Polyamide



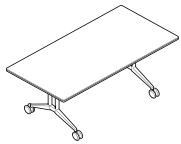
	Price		Price
150 / 075	10325	200 / 075	11508
150 / 080	10683	200 / 080	11956
150 / 090	11040	200 / 090	12418
150 / 100	11399	200 / 100	12868
160 / 075	10531	210 / 075	11713
160 / 080	10906	210 / 080	12197
160 / 090	11287	210 / 090	12666
160 / 100	11668	210 / 100	13142
170 / 075	10828	220 / 075	12035
170 / 080	11220	220 / 080	12524
170 / 090	11625	220 / 090	13028
170 / 100	12018	220 / 100	13515
180 / 075	11032	225 / 075	12146
180 / 080	11458	225 / 080	12636
180 / 090	11875	225 / 090	13145
180 / 100	12283	225 / 100	13646
190 / 075	11250		
190 / 080	11690		
190 / 090	12127		
190 / 100	12566		

E614-00B timetable shift basic

Product Options

Width	Depth	Top Surface	Edge
150 1500 220 2200	075 750	Pre-laminated Board	ABS Square Edge, R2
160 1600 225 2250	080 800		
170 1700	090 900		
180 1800	100 1000		
190 1900			
200 2000			
210 2100			

Under frame	Frame Upright	Foot Sections	Connectors
Steel, Black Coated	Tubular Steel, Black Coated	Aluminium, Black Coated	612 Polyamide



	Price
150 / 075	9314
150 / 080	9574
150 / 090	9821
150 / 100	10067
160 / 075	9474
160 / 080	9740
160 / 090	9997
160 / 100	10257
170 / 075	9712
170 / 080	9989
170 / 090	10263
170 / 100	10540
180 / 075	9862
180 / 080	10143
180 / 090	10439
180 / 100	10725
190 / 075	10019
190 / 080	10313
190 / 090	10615
190 / 100	10923

	Price
200 / 075	10199
200 / 080	10509
200 / 090	10834
200 / 100	11147
210 / 075	10349
210 / 080	10680
210 / 090	11010
210 / 100	11341
220 / 075	10607
220 / 080	10951
220 / 090	11290
220 / 100	11628
225 / 075	10688
225 / 080	11030
225 / 090	11374
225 / 100	11721

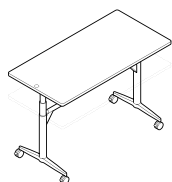
E615-00S timetable lift standard

Product Options

Width	Depth	Top Surface	Edge
150 1500	075 750	Laminex Commercial Range	Round Solid Timber w. Rubber
160 1600	080 800		
180 1800	090 900		
200 2000	100 1000		

Under frame	Frame Upright	Foot Sections
Steel, Black Coated	Tubular Steel, Black Coated	Aluminium, Polished

Notes 750 depth is only available if 1500 width is selected.
 800 depth is only available if 1600 width is selected.
 900 depth is only available if 1800 width is selected.
 1000 depth is only available if 2000 width is selected.
 Battery is included.



150 / 075
 160 / 080
 180 / 090
 200 / 100

Price

11528
11908
13112
15541

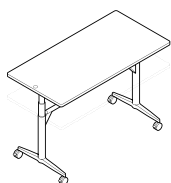
E615-00B timetable lift basic

Product Options

Width	Depth	Top Surface	Edge
150 1500	075 750	Pre-laminated Board	ABS Square Edge, R2
160 1600	080 800		
180 1800	090 900		
200 2000	100 1000		

Under frame	Frame Upright	Foot Sections
Steel, Black Coated	Tubular Steel, Black Coated	Aluminium, Black Coated

Notes 750 depth is only available if 1500 width is selected.
 800 depth is only available if 1600 width is selected.
 900 depth is only available if 1800 width is selected.
 1000 depth is only available if 2000 width is selected.
 Battery not included.



Price

150 / 075	10700
160 / 080	10962
180 / 090	11917
200 / 100	14352

teknion

www.teknion.com

CAN/US/INT 02-23
©Teknion 2026

®, ™ trade marks of Teknion Corporation and/or its subsidiaries or licensed to it. Patents may be pending.

Some products may not be available in all markets. Contact your local Teknion Representative for availability.

FEB26-AIH-PG